

- | | | | |
|--|--------------------------------|--|---------------------------------|
| | margini carosabil DN 2E | | rigola carosabila existenta |
| | limita proprietate | | rigola de acostament proiectata |
| | sant pamant existent | | acostament consolidat proiectat |
| | alei pietonale proiectate | | bordura mare proiectata |
| | directie scurgere ape pluviale | | bordura mica proiectata |
| | geiger descarcare ape pluviale | | |

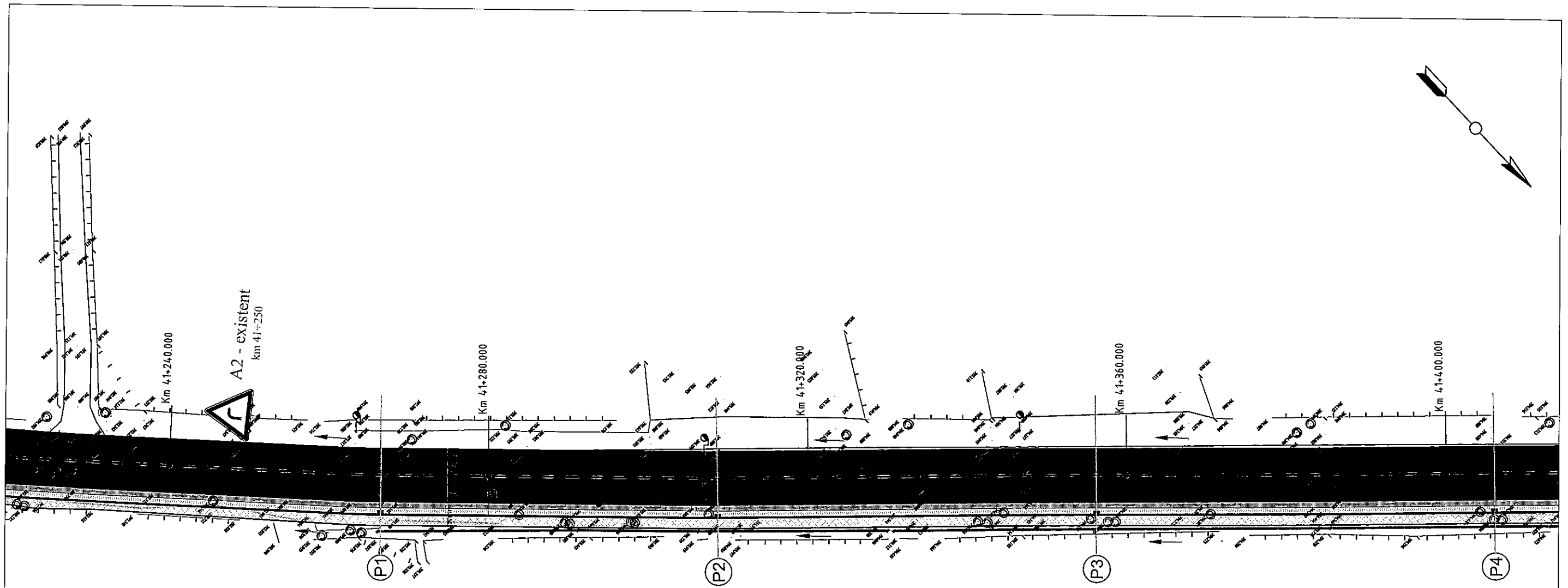

VERIFICATOR / EXPERT		NUME	SEMNTURA	CERINTA	REFERAT NR. / DATA
SC NORD STUDIO SRL J 33 / 191 / 2014					BENEFICIAR: COMUNA CACICA PROIECT: REFACERE SI MODERNIZARE ALEE PIETONALA AFERENTA DRUMULUI NATIONAL DN2E - PARTEA DREAPTA, IN SATUL PARTESTII DE SUS, COMUNA CACICA, JUDETUL SUCEAVA AMPLASAMENT: COMUNA CACICA, JUD. SUCEAVA
SEF PROIECT	Ing. Costiuc E.		SCARA	1:500	PROIECT NR. 269/2022
PROIECTAT	ing. Ursu T.		Plan de situatie		FAZA P.T.
DESENAT	ing. Postelnicu P.				2023



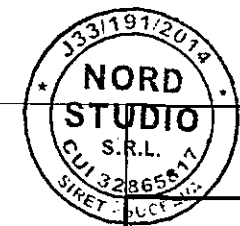

LEGENDA:

- | | | | |
|------------|--------------------------------|------------|---------------------------------|
| — | margini carosabil DN 2E | ◆◆◆◆◆◆◆◆◆◆ | rigola carosabila existentă |
| — | limita proprietate | ▨▨▨▨▨▨▨▨▨▨ | rigola de acostament proiectata |
| — | sant pamant existent | ▨▨▨▨▨▨▨▨▨▨ | acostament consolidat proiectat |
| ▨▨▨▨▨▨▨▨▨▨ | alei pietonale proiectate | — | bordura mare proiectata |
| → | directie scurgere ape pluviale | — | bordura mica proiectata |
| ▨▨▨▨▨▨▨▨▨▨ | geiger descarcare ape pluviale | | |



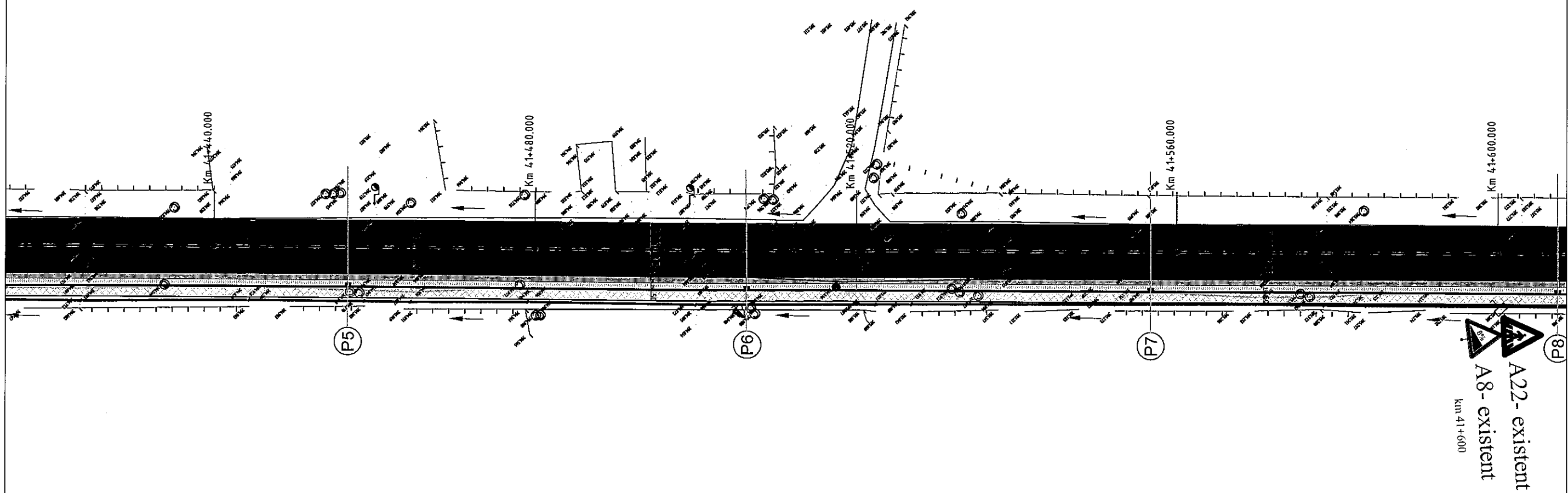
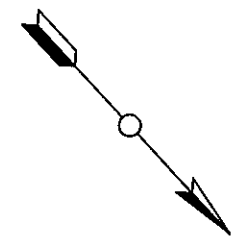







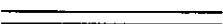

VERIFICATOR / EXPERT	NUME	SEMNATURA	CERINTA	REFERAT NR. / DATA
SC NORD STUDIO SRL J 33 / 191 / 2014				BENEFICIAR: COMUNA CACICA PROIECT: REFACERE SI MODERNIZARE ALEI PIETONALA AFERENTA DRUMULUI NATIONAL DN2E - PARTEA DREAPTA, IN SATUL PARTESTII DE SUS, COMUNA CACICA, JUDETUL SUCEAVA AMPLASAMENT: COMUNA CACICA, JUD. SUCEAVA
SEF PROIECT	ing. Costiuc E.	<i>[Signature]</i>	SCARA	PROIECT NR. 269/2022
PROIECTAT	ing. Ursu T.	<i>[Signature]</i>	1:500	FAZA P.T.
DESENAT	ing. Postelnicu P.	<i>[Signature]</i>	2023	PLANSA D.2.2
Plan de situatie				



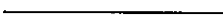

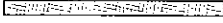
 A22 - existent
 A8 - existent
 km 41+600

LEGENDA:

- | | | | |
|---|--------------------------------|--|---------------------------------|
|  | margini carosabil DN 2E |  | rigola carosabila existentă |
|  | limita proprietate |  | rigola de acostament proiectata |
|  | sant pamant existent |  | acostament consolidat proiectat |
|  | alei pietonale proiectate |  | bordura mare proiectata |
|  | directie scurgere ape pluviale |  | bordura mica proiectata |
|  | geiger descarcare ape pluviale | | |

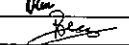

VERIFICATOR / EXPERT	NUME	SEMNATURA	CERINTA	REFERAT NR. / DATA
SC NORD STUDIO SRL J 33 / 191 / 2014				BENEFICIAR: COMUNA CACICA PROIECT: REFACERE SI MODERNIZARE ALEE PIETONALA AFERENTA DRUMULUI NATIONAL DN2E - PARTEA DREAPTA, IN SATUL PARTESTII DE SUS, COMUNA CACICA, JUDETUL SUCEAVA AMPLASAMENT: COMUNA CACICA, JUD. SUCEAVA
SEF PROIECT	ing. Costiuc E.		SCARA	PROIECT NR. 269/2022
PROIECTAT	ing. Ursu T.		1:500	FAZA P.T.
DESENAT	ing. Postelnicu P.		2023	PLANSA D.2.3
Plan de situatie				

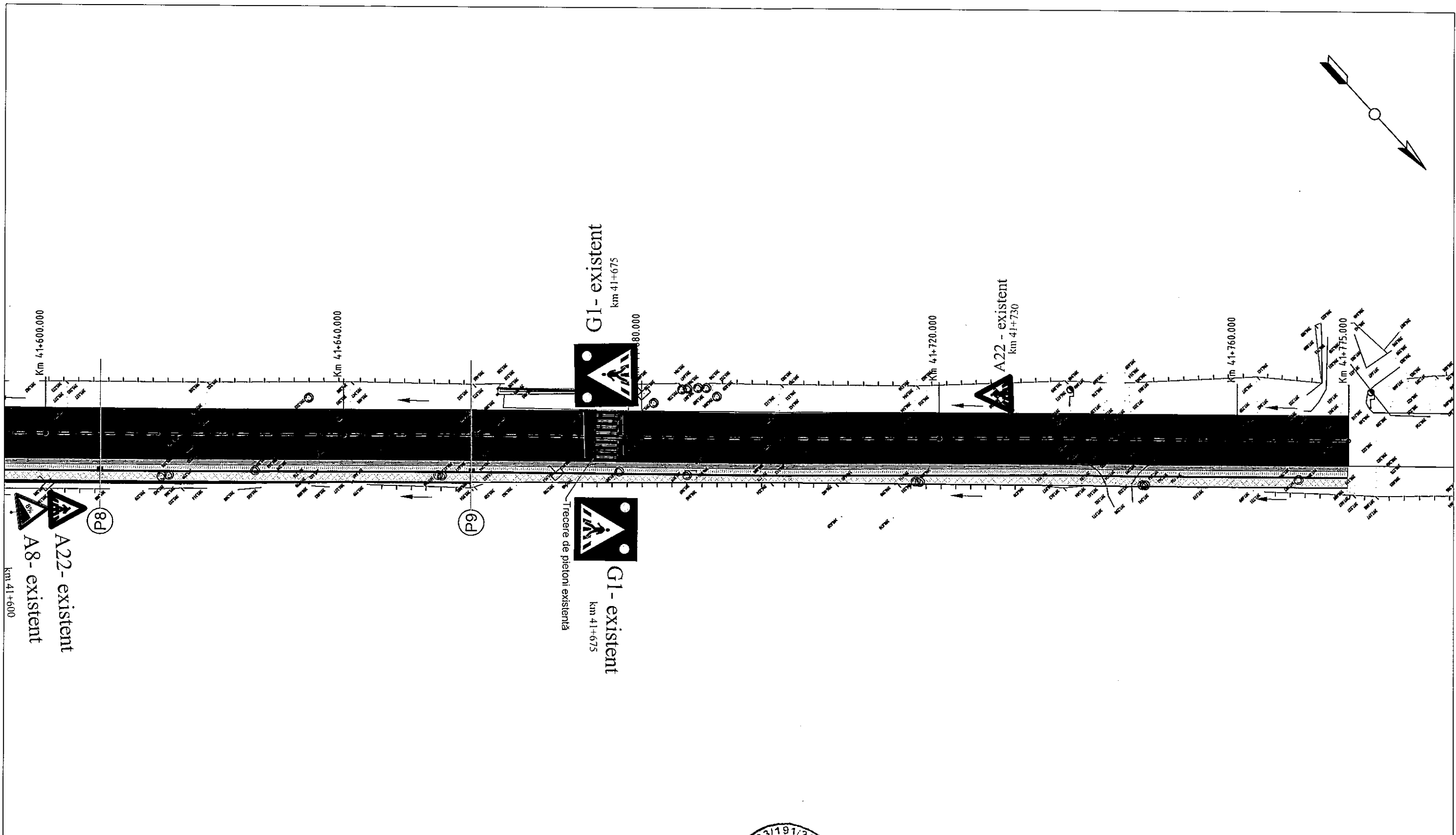
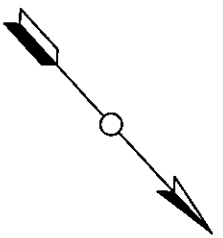

LEGENDA:

- margini carosabil DN 2E
- limita proprietate
- sant pamant existent
- alei pietonale proiectate
- > directie scurgere ape pluviale
- geiger descarcare ape pluviale
- rigola carosabila existenta
- rigola de acostament proiectata
- acostament consolidat proiectat
- bordura mare proiectata
- bordura mica proiectata

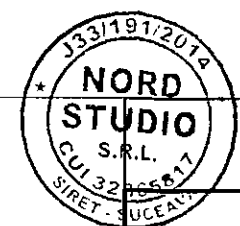

					REFERAT NR. / DATA
VERIFICATOR / EXPERT	NUME	SEMNATURA	CERINTA	BENEFICIAR: COMUNA CACICA	
SC NORD STUDIO SRL J 33 / 191 / 2014				PROIECT NR. 269/2022	
SEF PROIECT ing. Costiuc E.				PROIECT: REFACERE SI MODERNIZARE ALEE PIETONALA AFERENTA DRUMULUI NATIONAL DN2E - PARTEA DREAPTA, IN SATUL PARTESTII DE SUS, COMUNA CACICA, JUDETUL SUCEAVA	
PROIECTAT ing. Ursu T.				AMPLASAMENT: COMUNA CACICA, JUD. SUCEAVA	
DESENAT ing. Postelnicu P.				FAZA P.T.	
SCARA 1:500				Plan de situatie	
2023				PLANSA D.2.4	

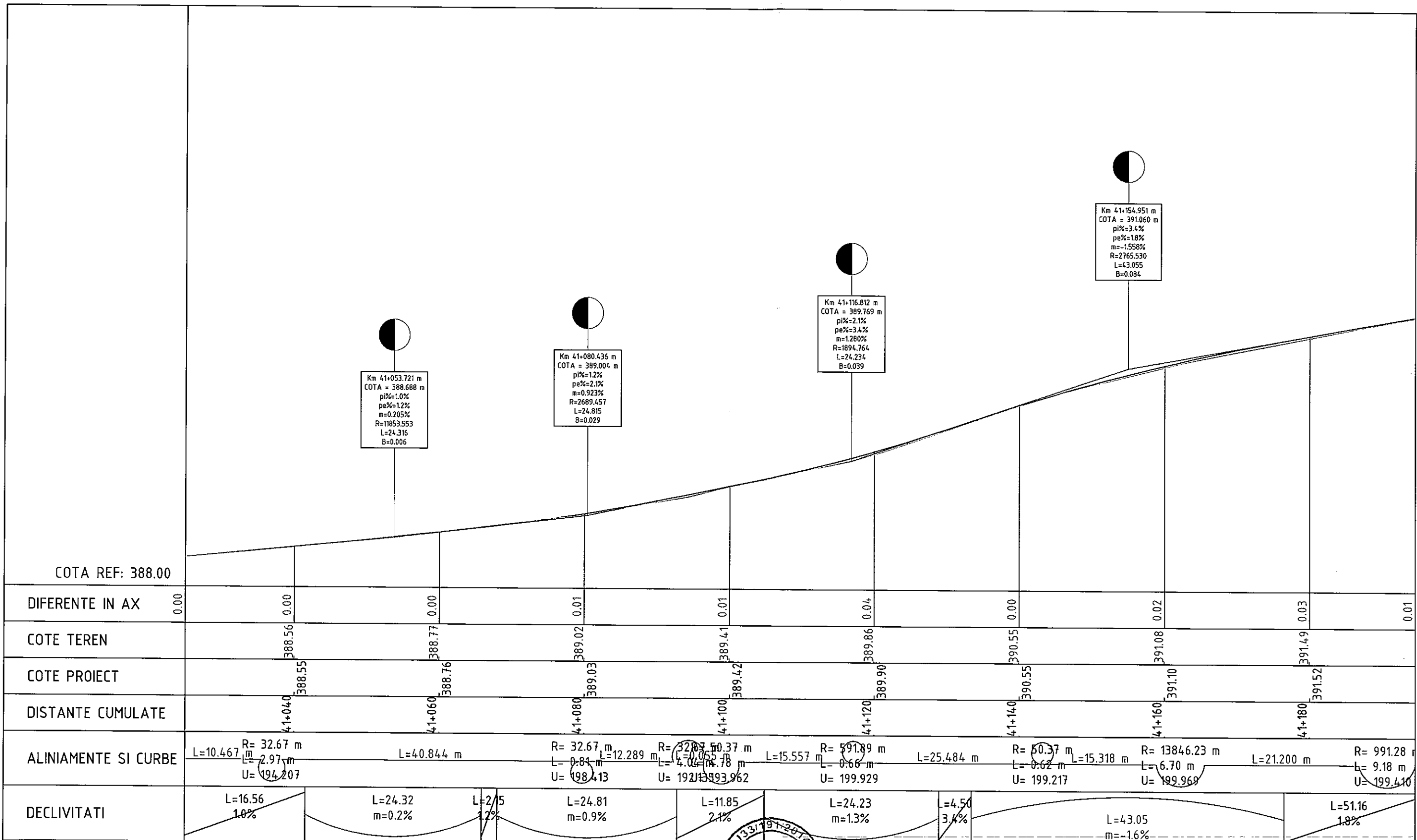

COTA REF: 388.00																			
DIFERENTE IN AX	0.00	0.00	0.00	0.01	0.01	0.04	0.00	0.02	0.03	0.01									
COTE TEREN		388.56	388.77	389.02	389.41	389.86	390.55	391.08	391.49										
COTE PROIECT		388.55	388.76	389.03	389.42	389.90	390.55	391.10	391.52										
DISTANTE CUMULATE		41+040	41+060	41+080	41+100	41+120	41+140	41+160	41+180										
ALINIAMENTE SI CURBE	L=10.467 R= 32.67 m L= 2.97 m U= 194.207	L=40.844 m	R= 32.67 m L= 0.84 m U= 198.413	L=12.289 m R= 32.67 m L= 4.04 m U= 192.393.962	L=15.557 m R= 591.89 m L= 0.66 m U= 199.929	L=25.484 m R= 50.37 m L= 0.62 m U= 199.217	L=15.318 m R= 13846.23 m L= 6.70 m U= 199.969	L=21.200 m R= 991.28 m L= 9.18 m U= 199.410											
DECLIVITATI	L=16.56 1.0%	L=24.32 m=0.2%	L=2/5 1.2%	L=24.81 m=0.9%	L=11.85 2.1%	L=24.23 m=1.3%	L=4.50 3.4%	L=43.05 m=-1.6%	L=51.16 1.8%										



VERIFICATOR / EXPERT	NUME	SEMNATURA	CERINTA	REFERAT NR. / DATA
SC NORD STUDIO SRL J 33 / 191 / 2014				BENEFICIAR: COMUNA CACICA PROIECT: REFACERE SI MODERNIZARE ALEE PIETONALA AFERENTA DRUMULUI NATIONAL DN2E - PARTEA DREAPTA, IN SATUL PARTESTII DE SUS, COMUNA CACICA, JUDETEL SUCEAVA AMPLASAMENT: COMUNA CACICA, JUD. SUCEAVA
SEF PROIECT	ing. Costiuc E.		SCARA	PROIECT NR.
PROIECTAT	ing. Ursu T.		1:500/1:50	269/2022
DESENAT	ing. Postelnicu P.		2023	FAZA P.T.
Profil longitudinal DN 2E				PLANSA D.3.1

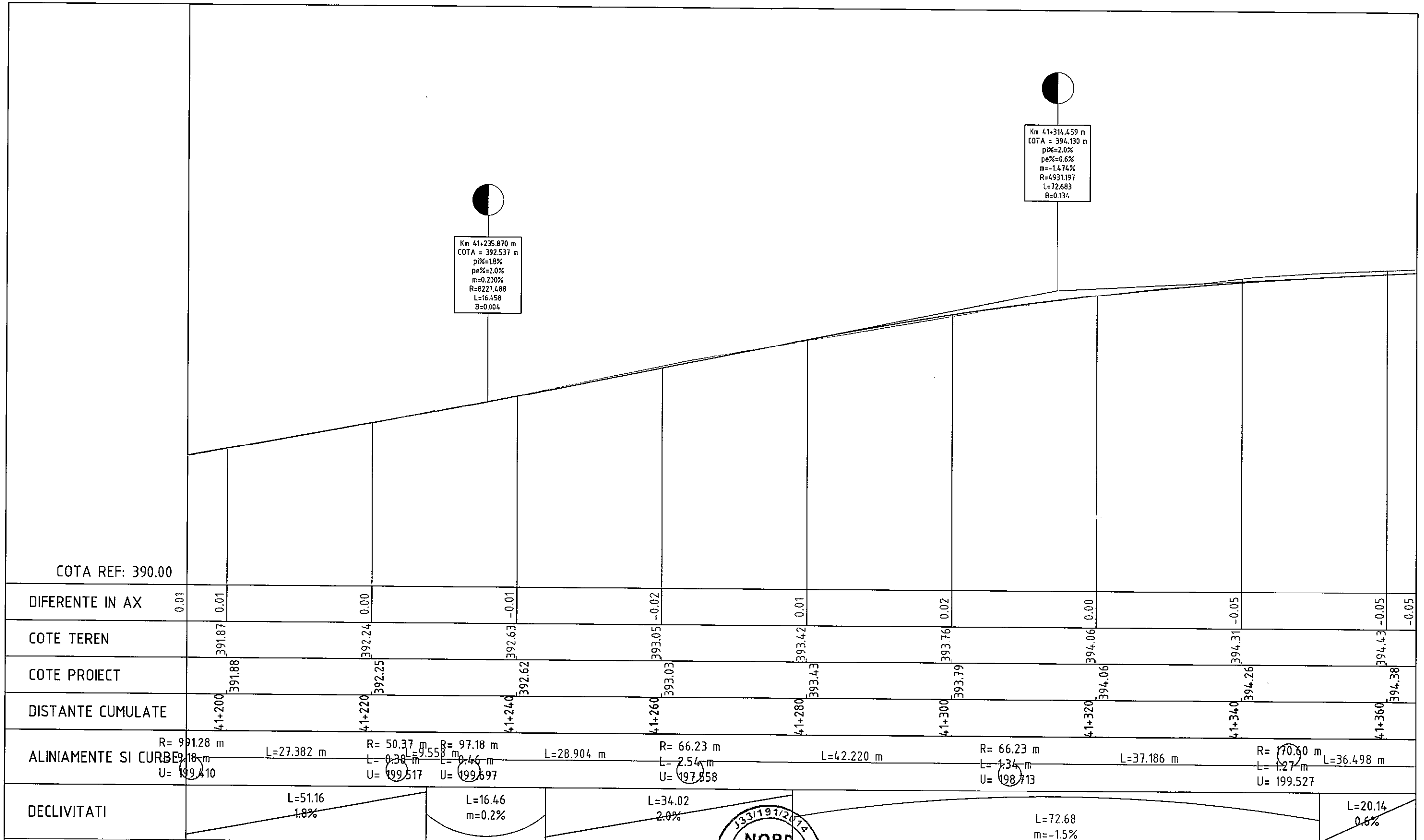

COTA REF: 390.00	
DIFERENTE IN AX	0.01 0.01 0.00 -0.01 -0.02 0.01 0.02 0.00 -0.05 -0.05
COTE TEREN	391.87 392.24 392.63 393.05 393.42 393.76 394.06 394.31 394.43
COTE PROIECT	391.88 392.25 392.62 393.03 393.43 393.79 394.06 394.26 394.38
DISTANTE CUMULATE	41+200 41+220 41+240 41+260 41+280 41+300 41+320 41+340 41+360
ALINIAMENTE SI CURBE	R= 991.28 m L=27.382 m R= 50.37 m L= 0.38 m R= 97.18 m L= 9.558 m L=28.904 m R= 66.23 m L= 2.54 m L=42.220 m R= 66.23 m L= 1.34 m L=37.186 m R= 170.60 m L= 1.27 m L=36.498 m U= 199.410 U= 199.517 U= 199.697 U= 197.858 U= 198.713 U= 199.527
DECLIVITATI	L=51.16 1.8% L=16.46 m=0.2% L=34.02 2.0% L=72.68 m=-1.5% L=20.14 0.6%

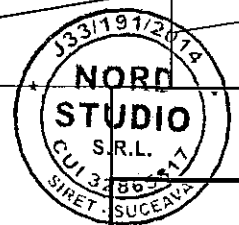

VERIFICATOR / EXPERT	NUME	SEMNATURA	CERINTA	REFERAT NR. / DATA
SC NORD STUDIO SRL J 33 / 191 / 2014				BENEFICIAR: COMUNA CACICA PROIECT: REFACERE SI MODERNIZARE ALEE PIETONALA AFERENTA DRUMULUI NATIONAL DN2E - PARTEA DREAPTA, IN SATUL PARTESTII DE SUS, COMUNA CACICA, JUDETUL SUCEAVA AMPLASAMENT: COMUNA CACICA, JUD. SUCEAVA
SEF PROIECT	ing. Costiuc E.		SCARA 1:500/1:50	PROIECT NR. 269/2022
PROIECTAT	ing. Ursu T.			FAZA P.T.
DESENAT	ing. Postelnicu P.		2023	PLANSA D.3.2
Profil longitudinal DN 2E				

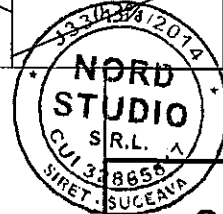
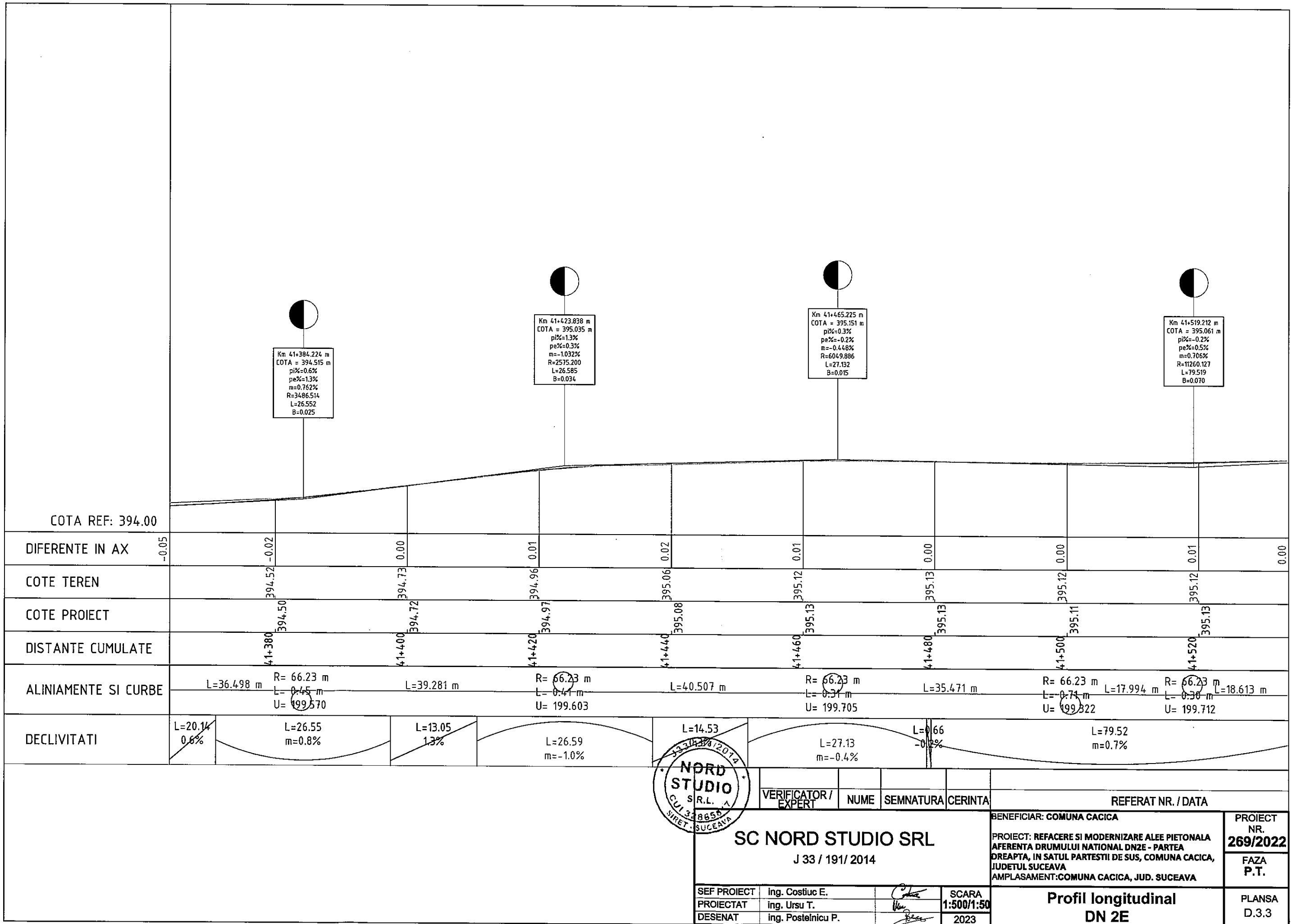

VERIFICATOR / EXPERT NUME SEMNATURA CERINTA

SC NORD STUDIO SRL
J 33 / 191 / 2014

BENEFICIAR: COMUNA CACICA
PROIECT: REFACERE SI MODERNIZARE ALEE PIETONALA AFERENTA DRUMULUI NATIONAL DN2E - PARTEA DREAPTA, IN SATUL PARTESTII DE SUS, COMUNA CACICA, JUDETUL SUCEAVA
AMPLASAMENT: COMUNA CACICA, JUD. SUCEAVA

PROIECT NR. **269/2022**
FAZA P.T.

SEF PROIECT ing. Costiuc E.
PROIECTAT ing. Ursu T.
DESENAT ing. Postelnicu P.

SCARA 1:500/1:50
2023

Profil longitudinal DN 2E

PLANSA D.3.3

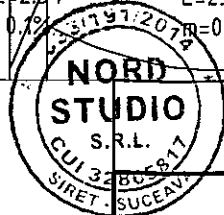
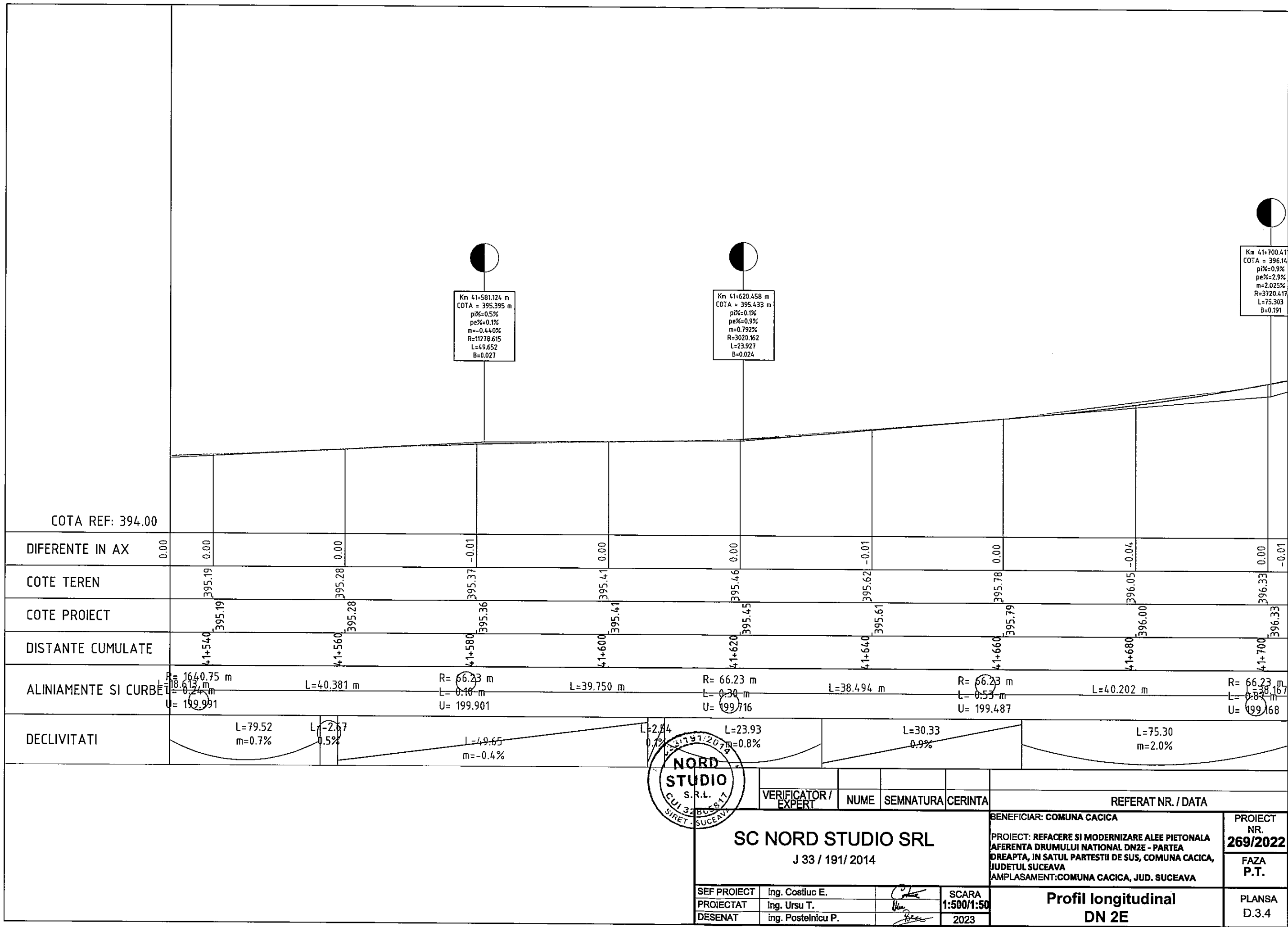

VERIFICATOR / EXPERT	NUME	SEMNATURA	CERINTA	REFERAT NR. / DATA
SC NORD STUDIO SRL J 33 / 191 / 2014				BENEFICIAR: COMUNA CACICA PROIECT: REFACERE SI MODERNIZARE ALEE PIETONALA AFERENTA DRUMULUI NATIONAL DN2E - PARTEA DREAPTA, IN SATUL PARTESTII DE SUS, COMUNA CACICA, JUDETUL SUCEAVA AMPLASAMENT: COMUNA CACICA, JUD. SUCEAVA
SEF PROIECT	ing. Costiuc E.	<i>[Signature]</i>	SCARA	Profil longitudinal DN 2E
PROIECTAT	ing. Ursu T.	<i>[Signature]</i>	1:500/1:50	
DESENAT	ing. Postelnicu P.	<i>[Signature]</i>	2023	
				PROIECT NR. 269/2022 FAZA P.T. PLANSA D.3.4

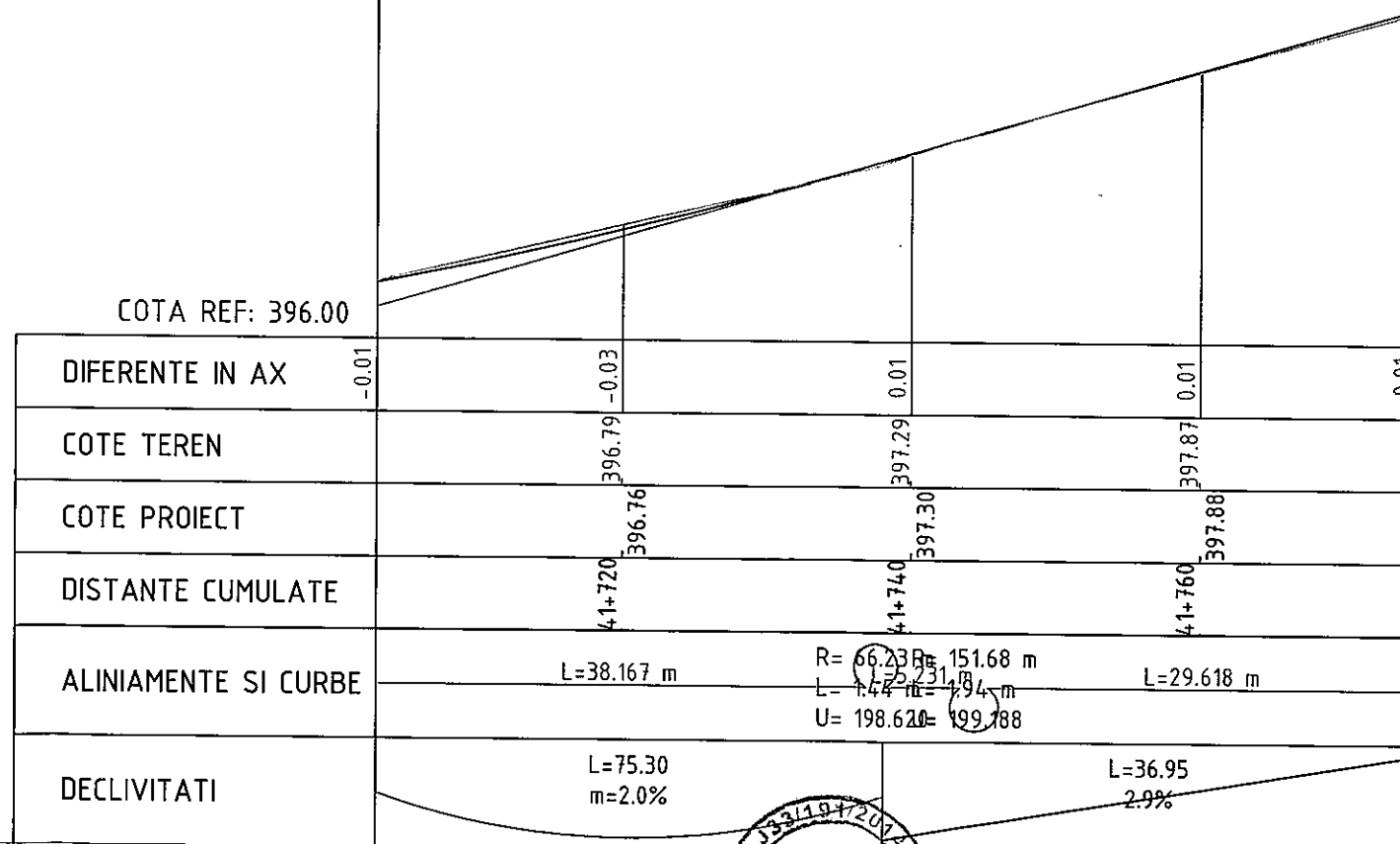

	COTA REF: 396.00				
DIFERENTE IN AX	-0.01	-0.03	0.01	0.01	-0.01
COTE TEREN		396.79	397.29	397.87	
COTE PROIECT		396.76	397.30	397.88	
DISTANTE CUMULATE		4+720	4+740	4+760	
ALINIAMENTE SI CURBE		L=38.167 m	R=66.23 m L=175.23 m U=198.620 m	L=151.68 m L=29.618 m	
DECLIVITATI		L=75.30 m=2.0%		L=36.95 2.9%	

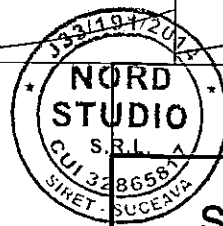

VERIFICATOR / EXPERT	NUME	SEMNATURA	CERINTA	REFERAT NR. / DATA
SC NORD STUDIO SRL J 33 / 191/ 2014				BENEFICIAR: COMUNA CACICA PROIECT: REFACERE SI MODERNIZARE ALEE PIETONALA AFERENTA DRUMULUI NATIONAL DN2E - PARTEA DREAPTA, IN SATUL PARTESTII DE SUS, COMUNA CACICA, JUDETUL SUCEAVA AMPLASAMENT: COMUNA CACICA, JUD. SUCEAVA
SEF PROIECT	ing. Costiuc E.	<i>Costiuc E.</i>	SCARA 1:500/1:50	PROIECT NR. 269/2022
PROIECTAT	ing. Ursu T.	<i>Ursu T.</i>	Profil longitudinal DN 2E	FAZA P.T.
DESENAT	ing. Postelnicu P.	<i>Postelnicu P.</i>		PLANSA D.3.5

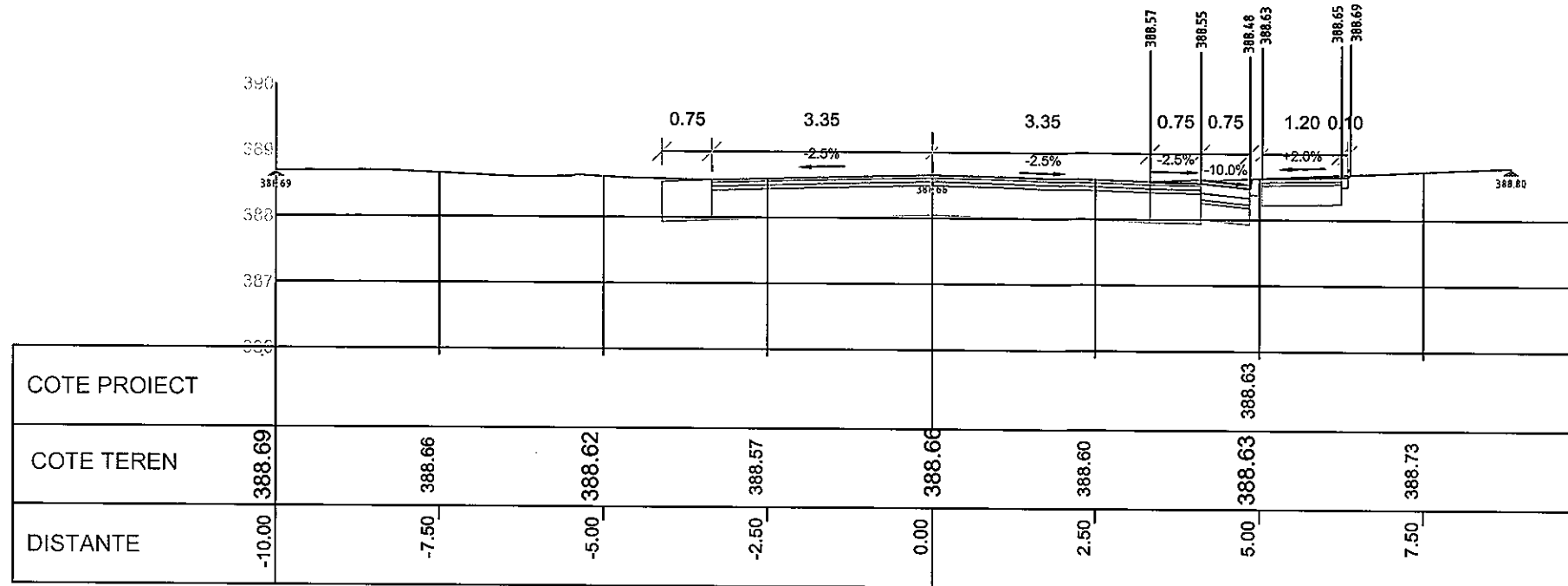

Km 41+050
Pichet nr.1

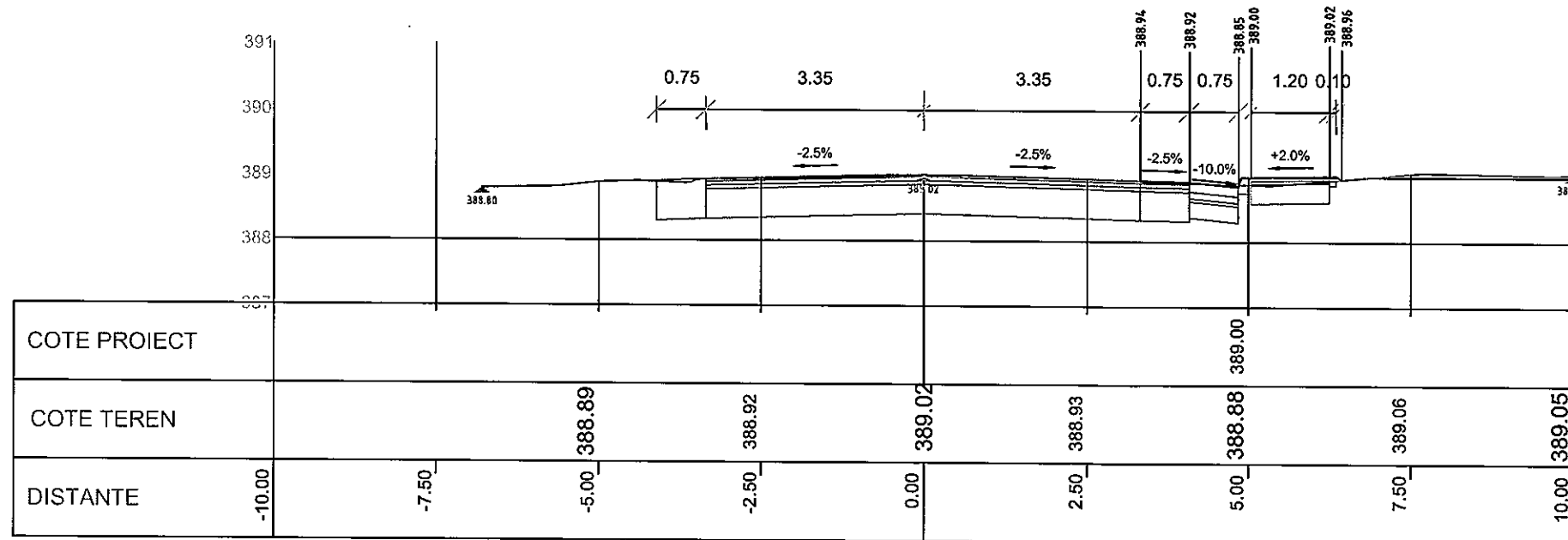

Km 41+080
Pichet nr.2

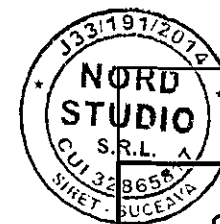

VERIFICATOR / EXPERT	NUME	SEMNATURA	CERINTA	REFERAT NR. / DATA
SC NORD STUDIO SRL J 33 / 191 / 2014				BENEFICIAR: COMUNA CACICA PROIECT: REFACERE SI MODERNIZARE ALEE PIETONALA AFERENTA DRUMULUI NATIONAL DN2E - PARTEA DREAPTA, IN SATUL PARTESTII DE SUS, COMUNA CACICA, JUDETUL SUCEAVA AMPLASAMENT: COMUNA CACICA, JUD. SUCEAVA
SEF PROIECT	ing. Costiuc E.		SCARA	PROIECT NR. 269/2022
PROIECTAT	ing. Ursu T.		1:100	FAZA P.T.
DESENAT	ina. Postelnicu P.		2022	PLANSA D.4.1

PROFIL TRANSVERSAL
CARACTERISTIC

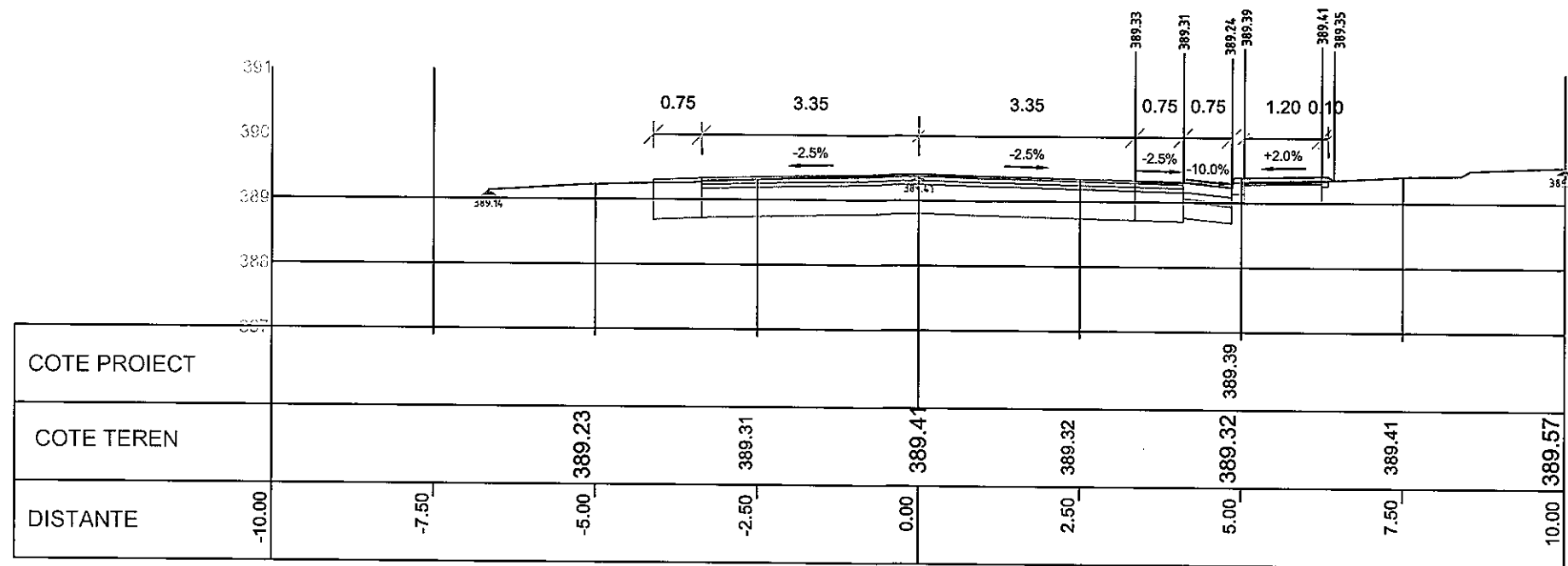

Km 41+100
Pichet nr.3

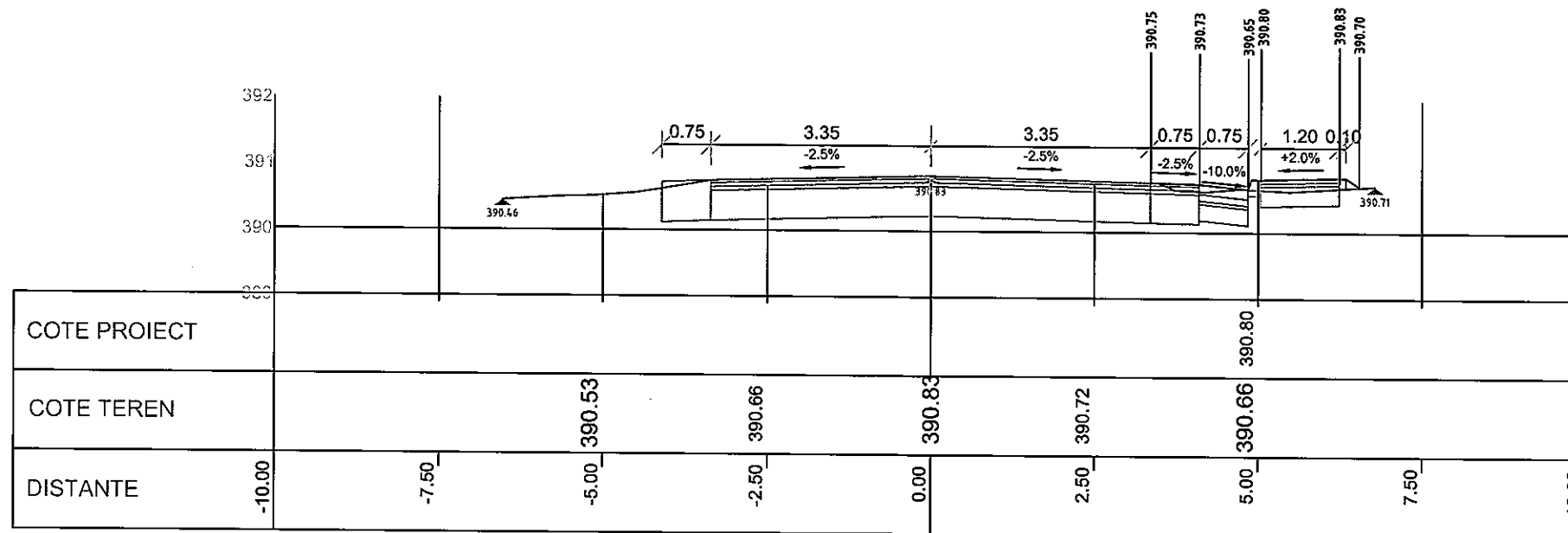

Km 41+150
Pichet nr.4

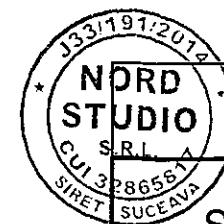

VERIFICATOR / EXPERT		NUME	SEMNATURA	CERINTA	REFERAT NR. / DATA
SC NORD STUDIO SRL J 33 / 191 / 2014					BENEFICIAR: COMUNA CACICA PROIECT: REFACERE SI MODERNIZARE ALEE PIETONALA AFERENTA DRUMULUI NATIONAL DN2E - PARTEA DREAPTA, IN SATUL PARTESTII DE SUS, COMUNA CACICA, JUDETUL SUCEAVA AMPLASAMENT: COMUNA CACICA, JUD. SUCEAVA
SEF PROIECT	ing. Costiuc E.			SCARA 1:100	PROIECT NR. 269/2022
PROIECTAT	ing. Ursu T.				FAZA P.T.
DESENAT	ina. Postelnicu P.			2022	PLANSA D.4.2

PROFIL TRANSVERSAL
CARACTERISTIC

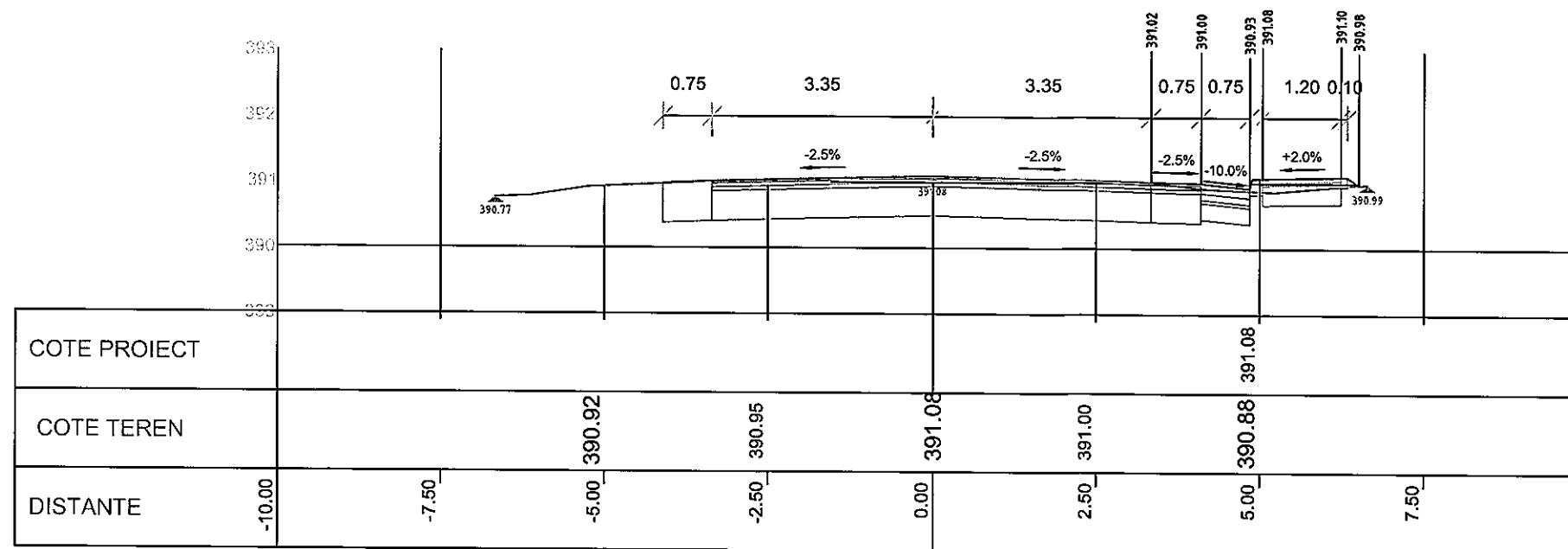

Km 41+160
Pichet nr.5

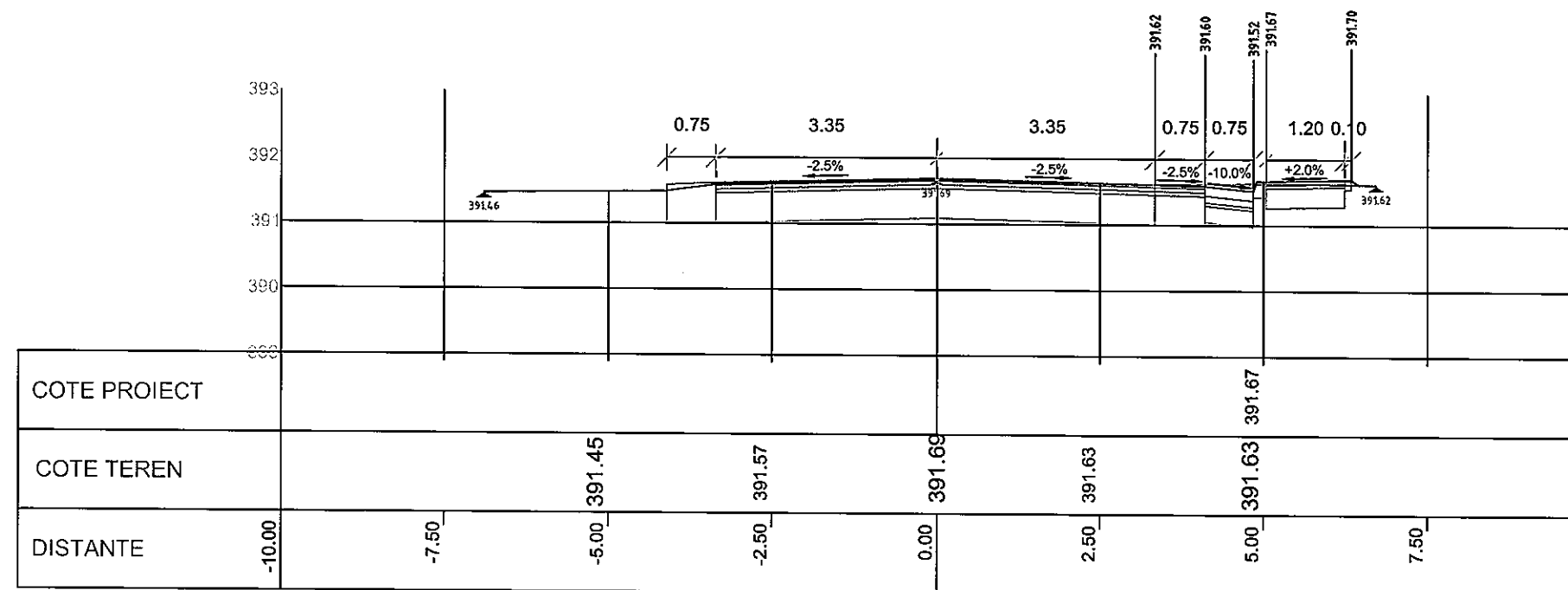

Km 41+190
Pichet nr.6



VERIFICATOR / EXPERT	NUME	SEMNTATURA	CERINTA	REFERAT NR. / DATA
SC NORD STUDIO SRL J 33 / 191 / 2014				BENEFICIAR: COMUNA CACICA PROIECT: REFACERE SI MODERNIZARE ALEE PIETONALA AFERENTA DRUMULUI NATIONAL DN2E - PARTEA DREAPTA, IN SATUL PARTESTII DE SUS, COMUNA CACICA, JUDETUL SUCEAVA AMPLASAMENT: COMUNA CACICA, JUD. SUCEAVA
SEF PROIECT	ing. Costiuc E.		SCARA 1:100	PROIECT NR. 269/2022
PROIECTAT	ing. Ursu T.			FAZA P.T.
DESENAT	ing. Postelnicu P.			PLANSA D.4.3
PROFIL TRANSVERSAL CARACTERISTIC				

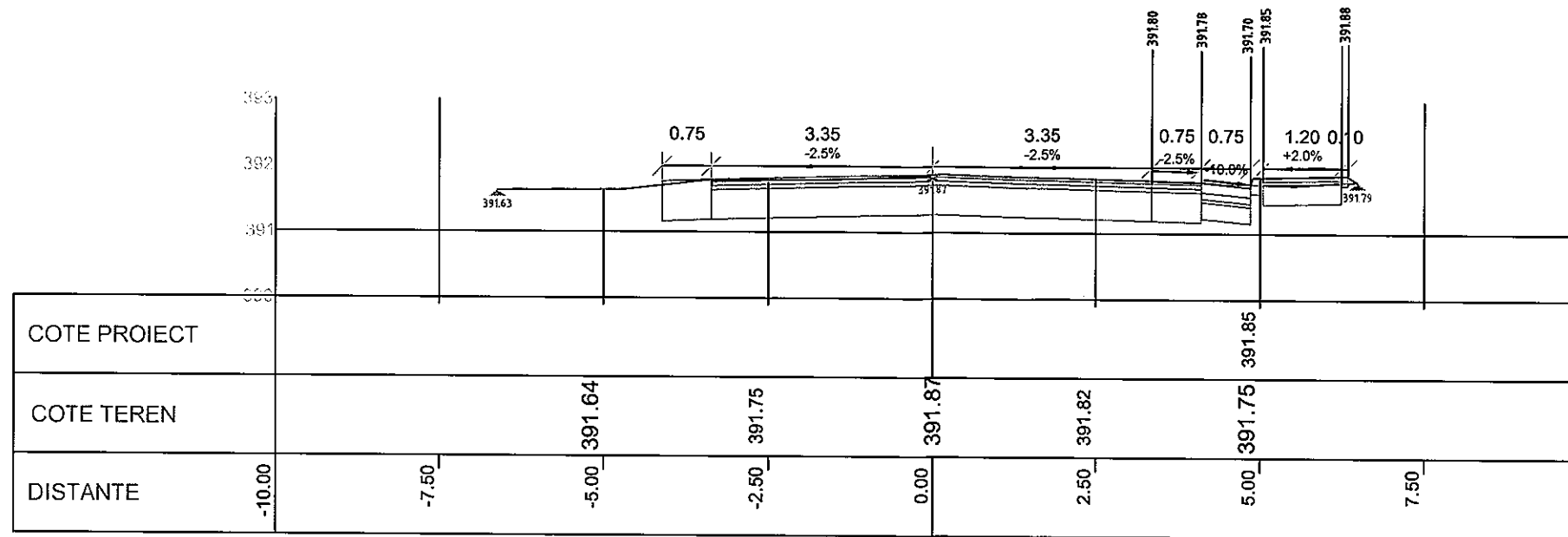

Km 41+200
Pichet nr.7

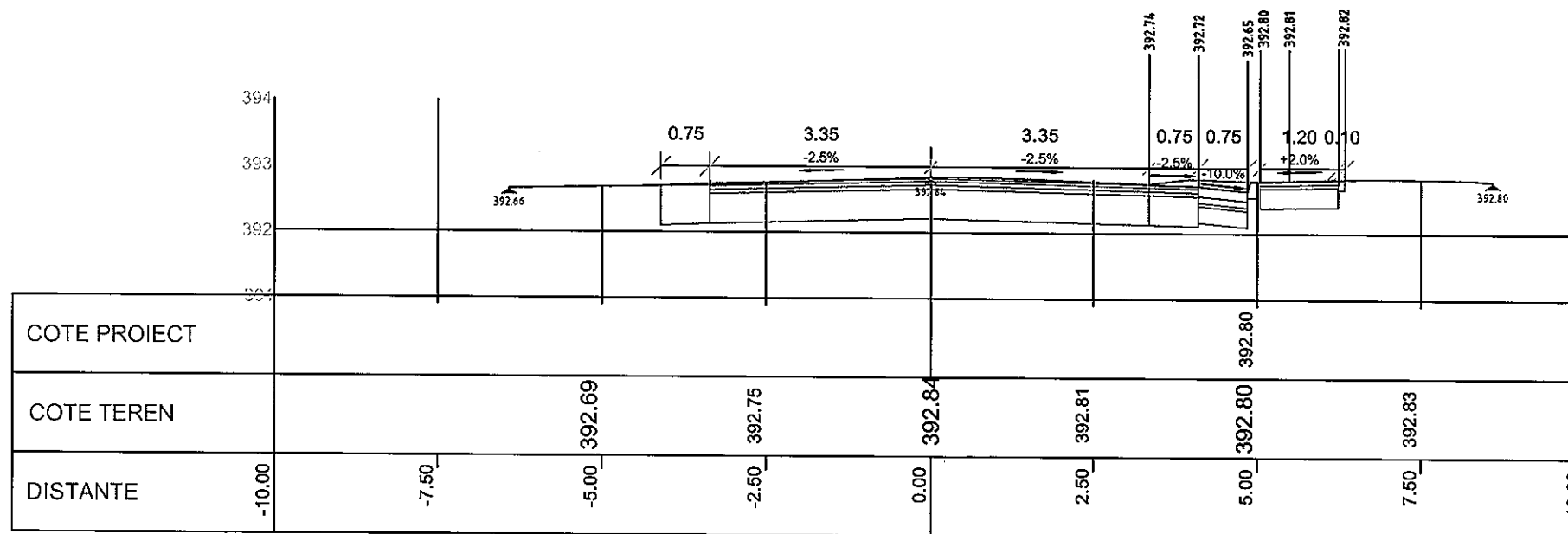

Km 41+250
Pichet nr.8

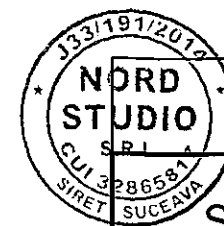

VERIFICATOR / EXPERT				NUME	SEMNTURA	CERINTA	REFERAT NR. / DATA	
SC NORD STUDIO SRL J 33 / 191 / 2014							BENEFICIAR: COMUNA CACICA PROIECT: REFACERE SI MODERNIZARE ALEE PIETONALA AFERENTA DRUMULUI NATIONAL DN2E - PARTEA DREAPTA, IN SATUL PARTESTII DE SUS, COMUNA CACICA, JUDETUL SUCEAVA AMPLASAMENT: COMUNA CACICA, JUD. SUCEAVA	PROIECT NR. 269/2022 FAZA P.T.
SEF PROIECT	ing. Costiuc E.					SCARA 1:100	PROFIL TRANSVERSAL CARACTERISTIC	
PROIECTAT	ing. Ursu T.							
DESENAT	ing. Postelnicu P.							
							PLANSA D.4.4	

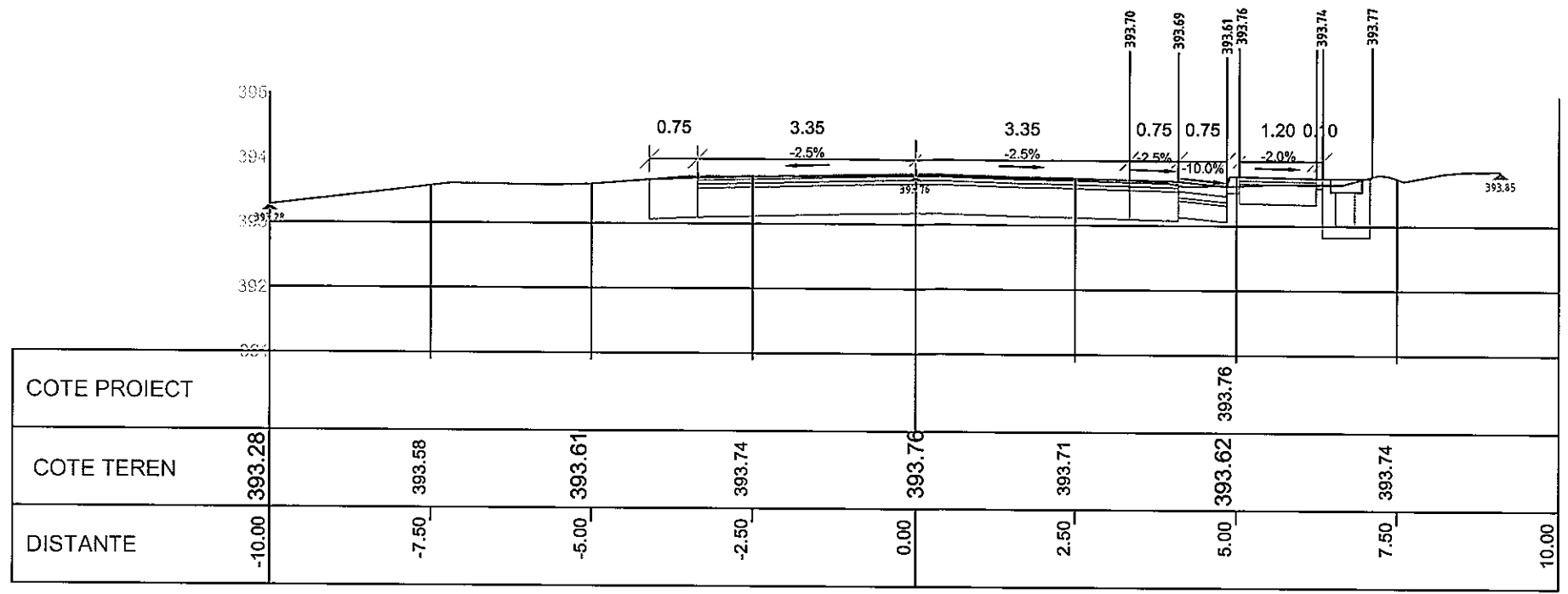

Km 41+300
Pichet nr.9

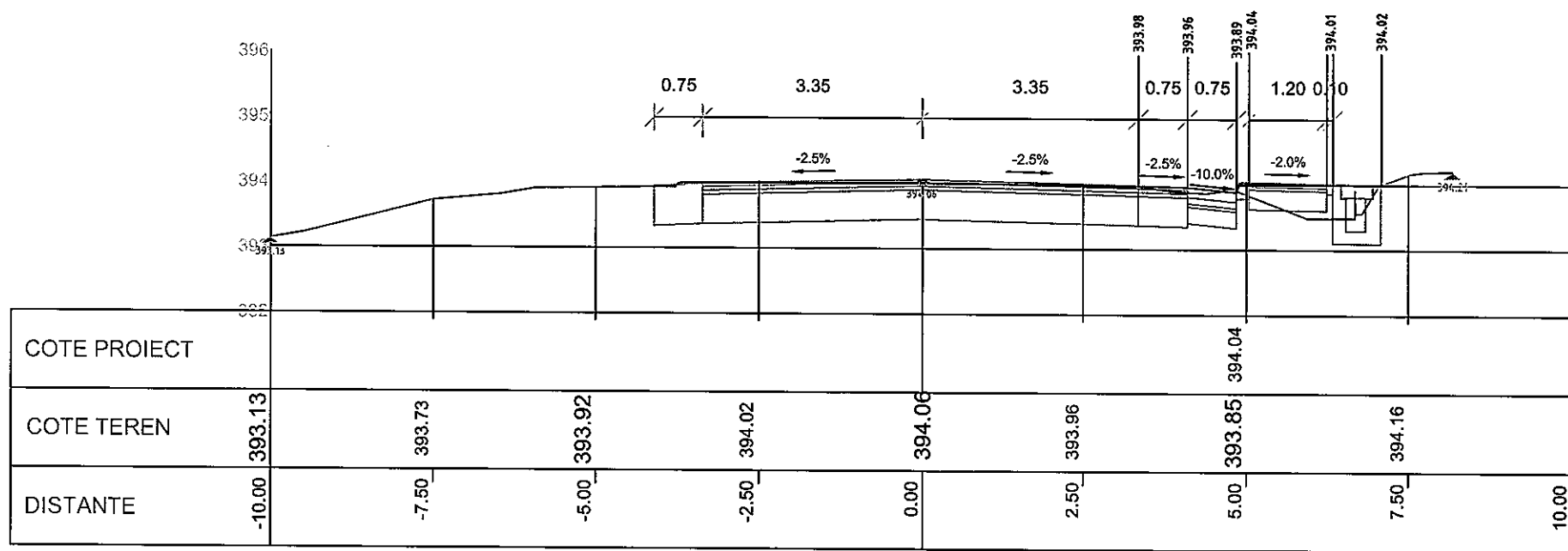

Km 41+320
Pichet nr.10

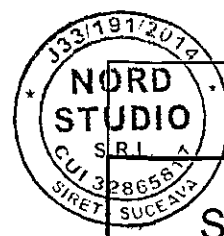

VERIFICATOR / EXPERT	NUME	SEMNATURA	CERINTA	REFERAT NR. / DATA
SC NORD STUDIO SRL J 33 / 191 / 2014				BENEFICIAR: COMUNA CACICA PROIECT: REFACERE SI MODERNIZARE ALEE PIETONALA AFERENTA DRUMULUI NATIONAL DN2E - PARTEA DREAPTA, IN SATUL PARTESTII DE SUS, COMUNA CACICA, JUDETUL SUCEAVA AMPLASAMENT: COMUNA CACICA, JUD. SUCEAVA
SEF PROIECT	ing. Costiuc E.	<i>Costiuc E.</i>	SCARA 1:100	PROIECT NR. 269/2022
PROIECTAT	ing. Ursu T.	<i>Ursu T.</i>		FAZA P.T.
DESENAT	ing. Postelnicu P.	<i>Postelnicu P.</i>		PLANSA D.4.5

**PROFIL TRANSVERSAL
CARACTERISTIC**

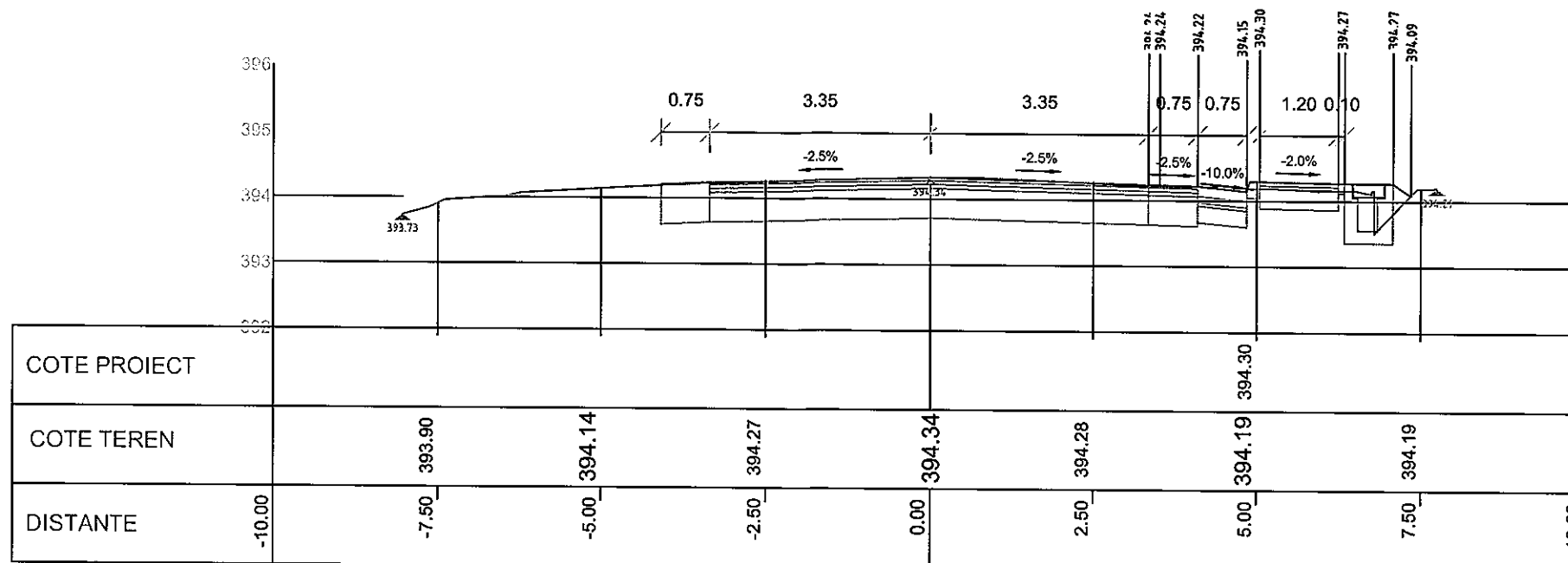

Km 41+350
Pichet nr.11

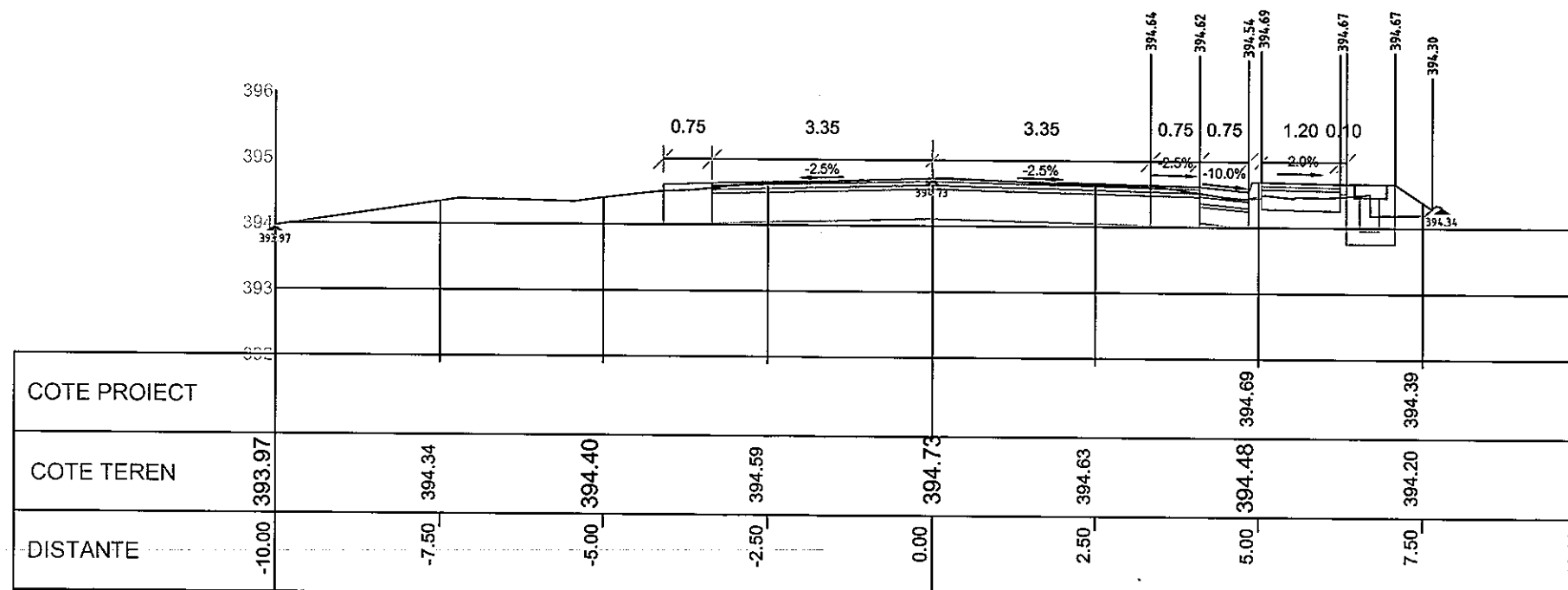

Km 41+400
Pichet nr.12



VERIFICATOR / EXPERT				NUME	SEMNATURA	CERINTA	REFERAT NR. / DATA	
SC NORD STUDIO SRL J 33 / 191 / 2014							BENEFICIAR: COMUNA CACICA PROIECT: REFACERE SI MODERNIZARE ALEE PIETONALA AFERENTA DRUMULUI NATIONAL DN2E - PARTEA DREAPTA, IN SATUL PARTESTII DE SUS, COMUNA CACICA, JUDETUL SUCEAVA AMPLASAMENT: COMUNA CACICA, JUD. SUCEAVA	PROIECT NR. 269/2022
SEF PROIECT	ing. Costiuc E.					SCARA 1:100	FAZA P.T.	
PROIECTAT	ing. Ursu T.						PLANSA D.4.6	
DESENAT	ing. Postelnicu P.					2023		

**PROFIL TRANSVERSAL
CARACTERISTIC**

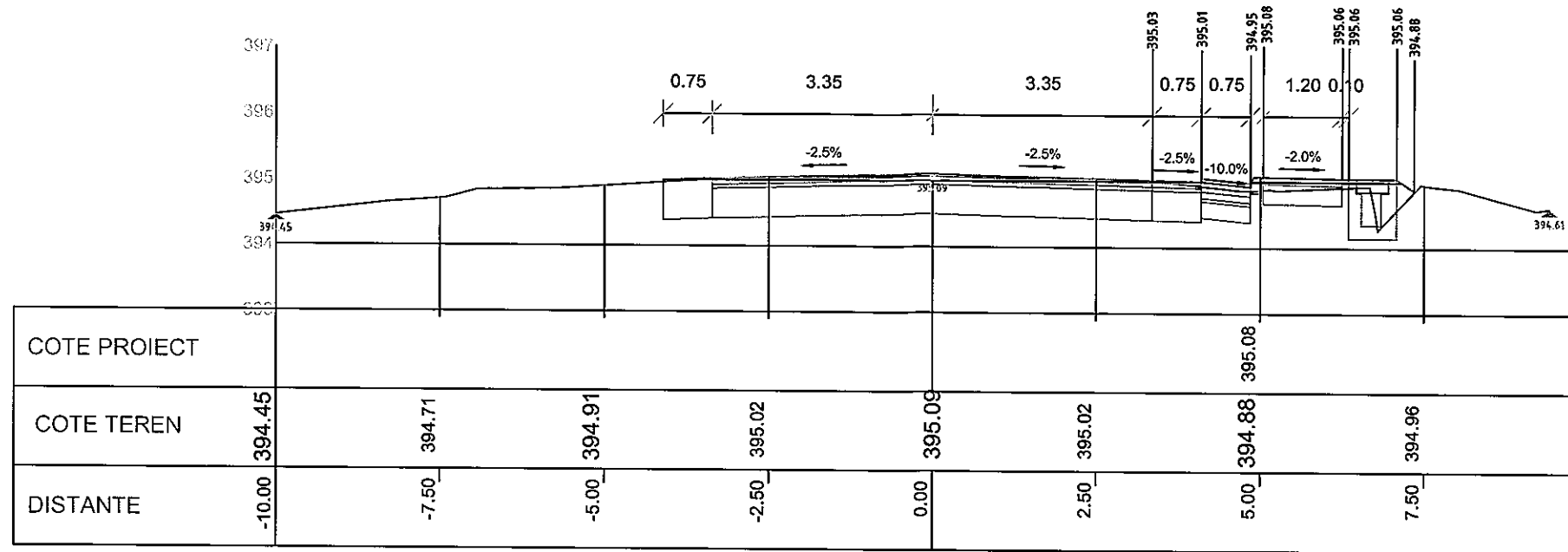

Km 41+450
Pichet nr.13

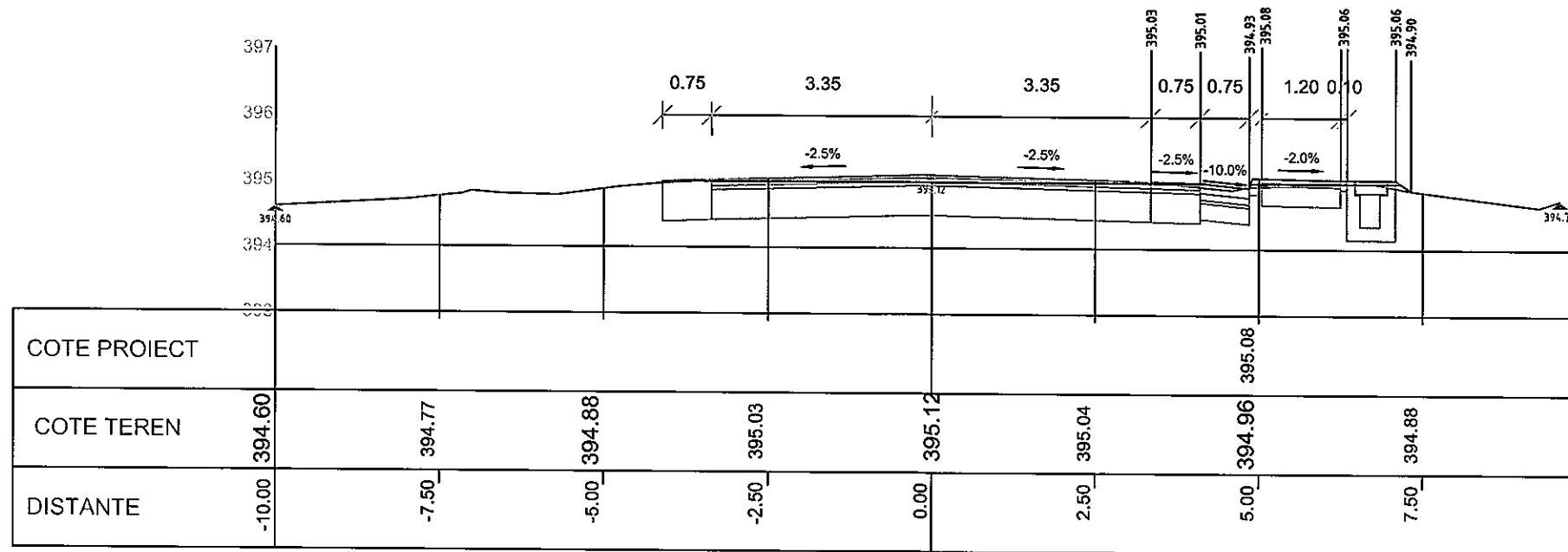

Km 41+500
Pichet nr.14



VERIFICATOR / EXPERT	NUME	SEMNATURA	CERINTA	REFERAT NR. / DATA
SC NORD STUDIO SRL J 33 / 191 / 2014				BENEFICIAR: COMUNA CACICA PROIECT: REFACERE SI MODERNIZARE ALEE PIETONALA AFERENTA DRUMULUI NATIONAL DN2E - PARTEA DREAPTA, IN SATUL PARTESTII DE SUS, COMUNA CACICA, JUDETUL SUCEAVA AMPLASAMENT: COMUNA CACICA, JUD. SUCEAVA
SEF PROIECT	ing. Costiuc E.		SCARA	PROIECT NR. 269/2022
PROIECTAT	ing. Ursu T.		1:100	FAZA P.T.
DESENAT	ina. Postelnicu P.		2022	PLANSA D.4.7

PROFIL TRANSVERSAL
CARACTERISTIC

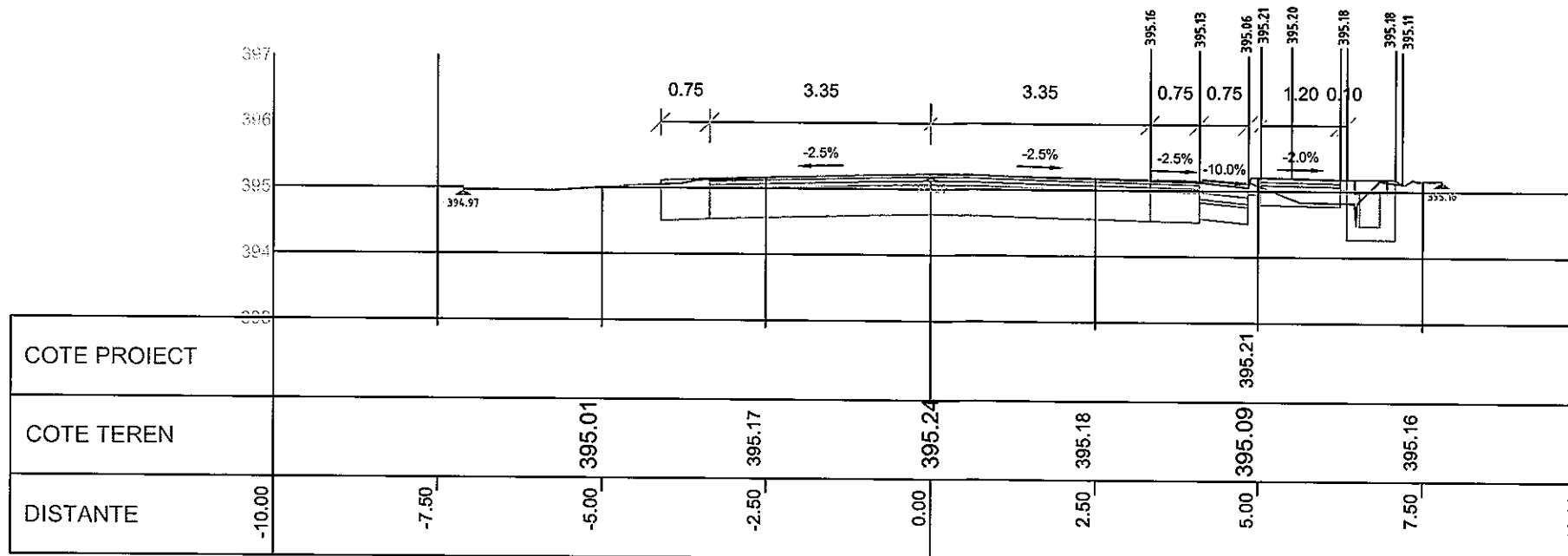

Km 41+550
Pichet nr.15

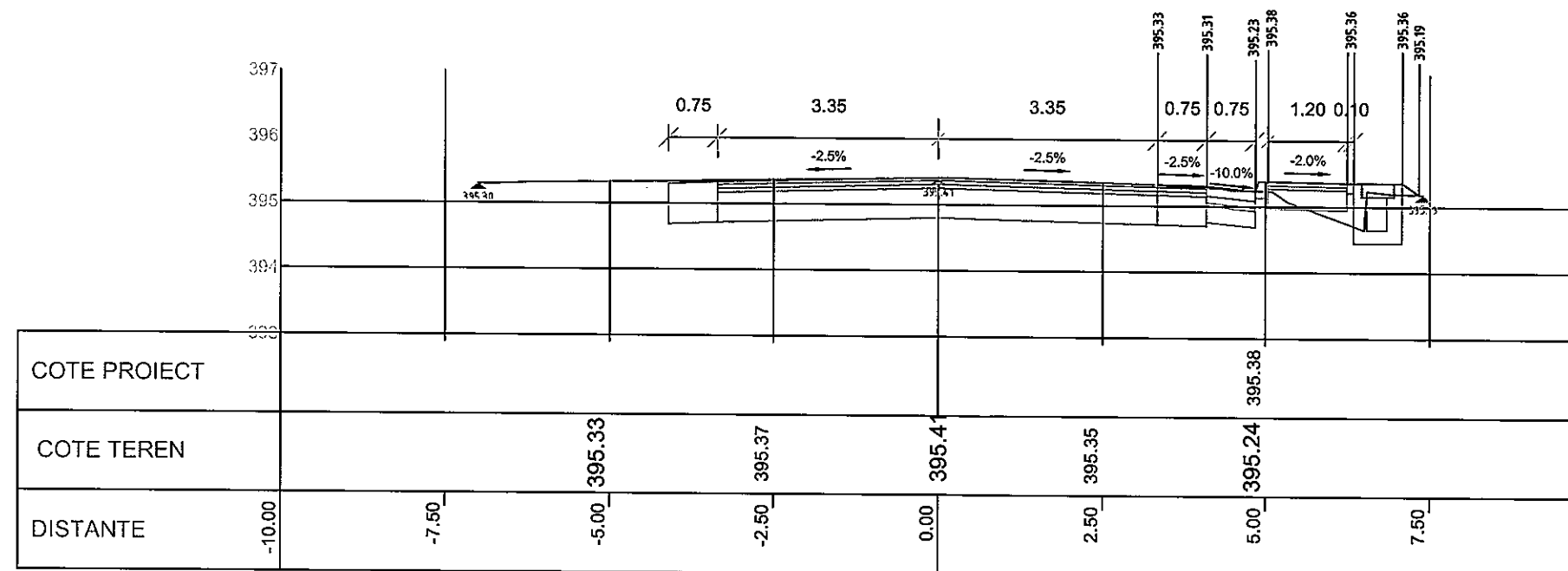

Km 41+600
Pichet nr.16



VERIFICATOR / EXPERT		NUME	SEMNATURA	GERINTA	REFERAT NR. / DATA
SC NORD STUDIO SRL J 33 / 191 / 2014					BENEFICIAR: COMUNA CACICA PROIECT: REFACERE SI MODERNIZARE ALEE PIETONALA AFERENTA DRUMULUI NATIONAL DN2E - PARTEA DREAPTA, IN SATUL PARTESTII DE SUS, COMUNA CACICA, JUDETUL SUCEAVA AMPLASAMENT: COMUNA CACICA, JUD. SUCEAVA
SEF PROIECT	ing. Costiuc E.			SCARA	PROIECT NR. 269/2022
PROIECTAT	ing. Ursu T.			1:100	FAZA P.T.
DESENAT	ina. Postelnicu P.			2022	PLANSA D.4.8

PROFIL TRANSVERSAL
CARACTERISTIC

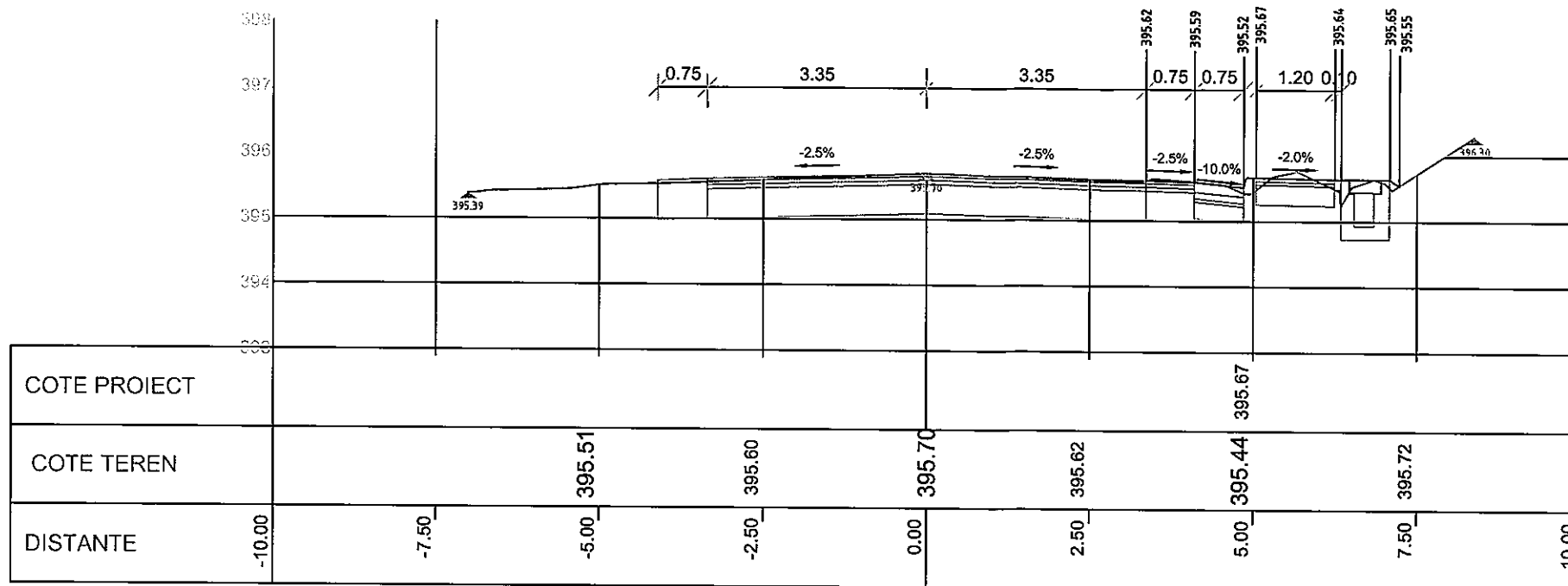

Km 41+650
Pichet nr.17

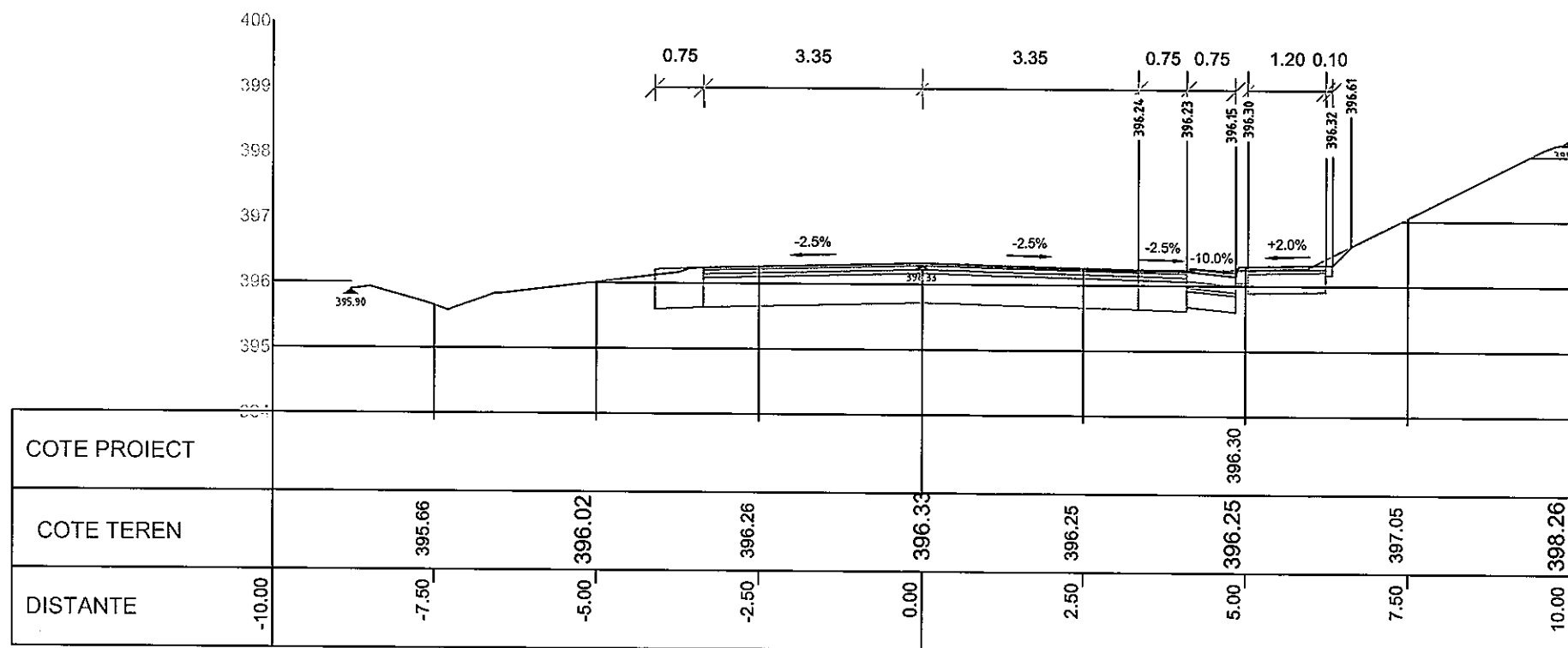

Km 41+700
Pichet nr.18

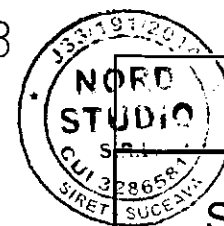

VERIFICATOR / EXPERT				NUME	SEMNATURA	CERINTA	REFERAT NR. / DATA
SC NORD STUDIO SRL				J 33 / 191 / 2014		BENEFICIAR: COMUNA CACICA PROIECT: REFACERE SI MODERNIZARE ALEE PIETONALA AFERENTA DRUMULUI NATIONAL DN2E - PARTEA DREAPTA, IN SATUL PARTESTII DE SUS, COMUNA CACICA, JUDETUL SUCEAVA AMPLASAMENT: COMUNA CACICA, JUD. SUCEAVA	
SEF PROIECT	ing. Costiuc E.			SCARA	PROIECT NR. 269/2022		
PROIECTAT	ing. Ursu T.			1:100	FAZA P.T.		
DESENAT	ina. Postelnicu P.			2022	PLANSĂ D.4.9		
PROFIL TRANSVERSAL CARACTERISTIC							

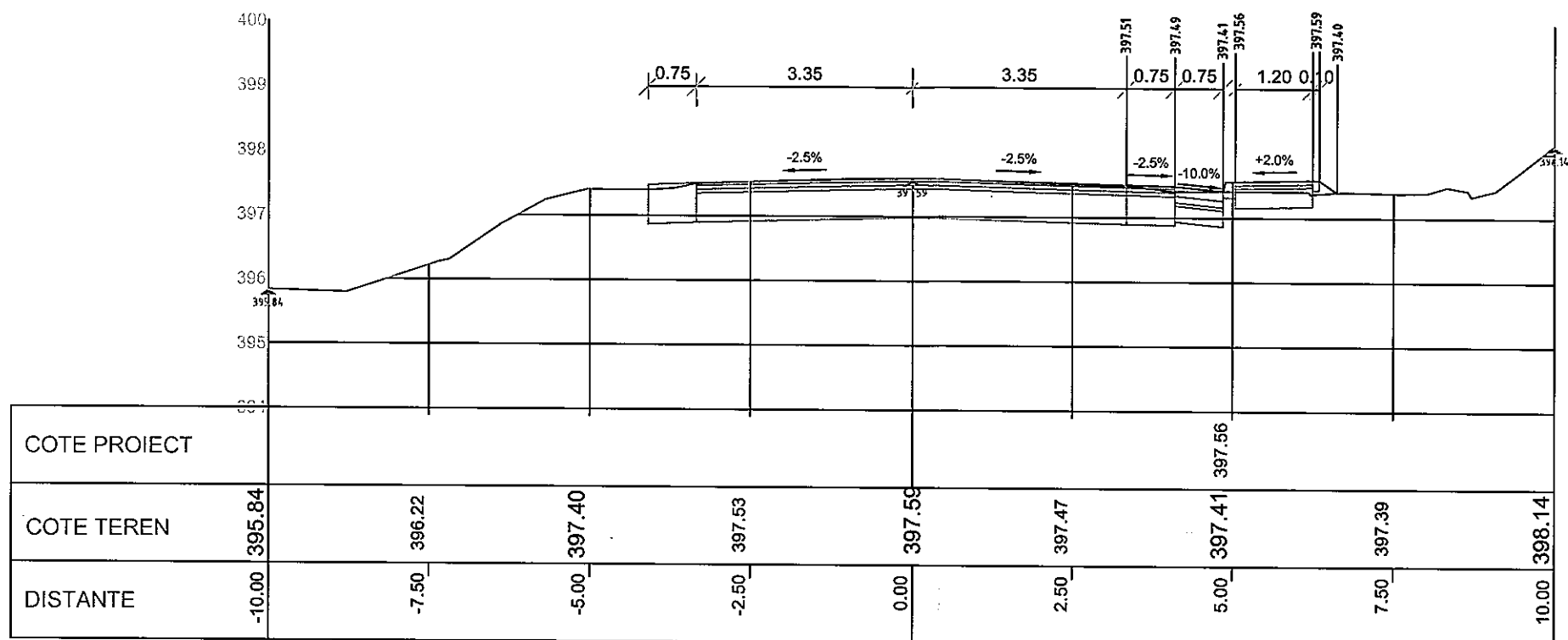

Km 41+750
Pichet nr.19



VERIFICATOR / EXPERT		NUME	SEMNATURA	CERINTA	REFERAT NR. / DATA	
SC NORD STUDIO SRL J 33 / 191 / 2014					BENEFICIAR: COMUNA CACICA PROIECT: REFACERE SI MODERNIZARE ALEE PIETONALA AFERENTA DRUMULUI NATIONAL DN2E - PARTEA DREAPTA, IN SATUL PARTESTII DE SUS, COMUNA CACICA, JUDETUL SUCEAVA AMPLASAMENT: COMUNA CACICA, JUD. SUCEAVA	
SEF PROIECT	ing. Costiuc E.				PROIECT NR. 269/2022	FAZA P.T.
PROIECTAT	ing. Ursu T.				PLANSA D.4.10	
DESENAT	ing. Postelnicu P.			SCARA 1:100	PROFIL TRANSVERSAL CARACTERISTIC	

Se aplica de la km 41+025 la km 41+267
 Se aplica de la km 41+657 la km 41+775

Detaliu scurgere ape pluviale in geigere

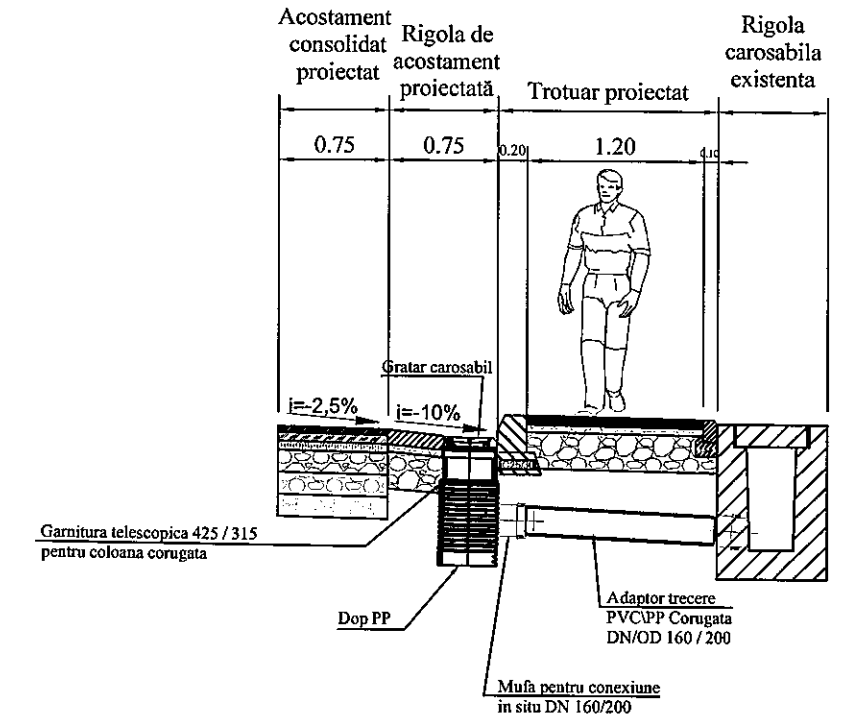
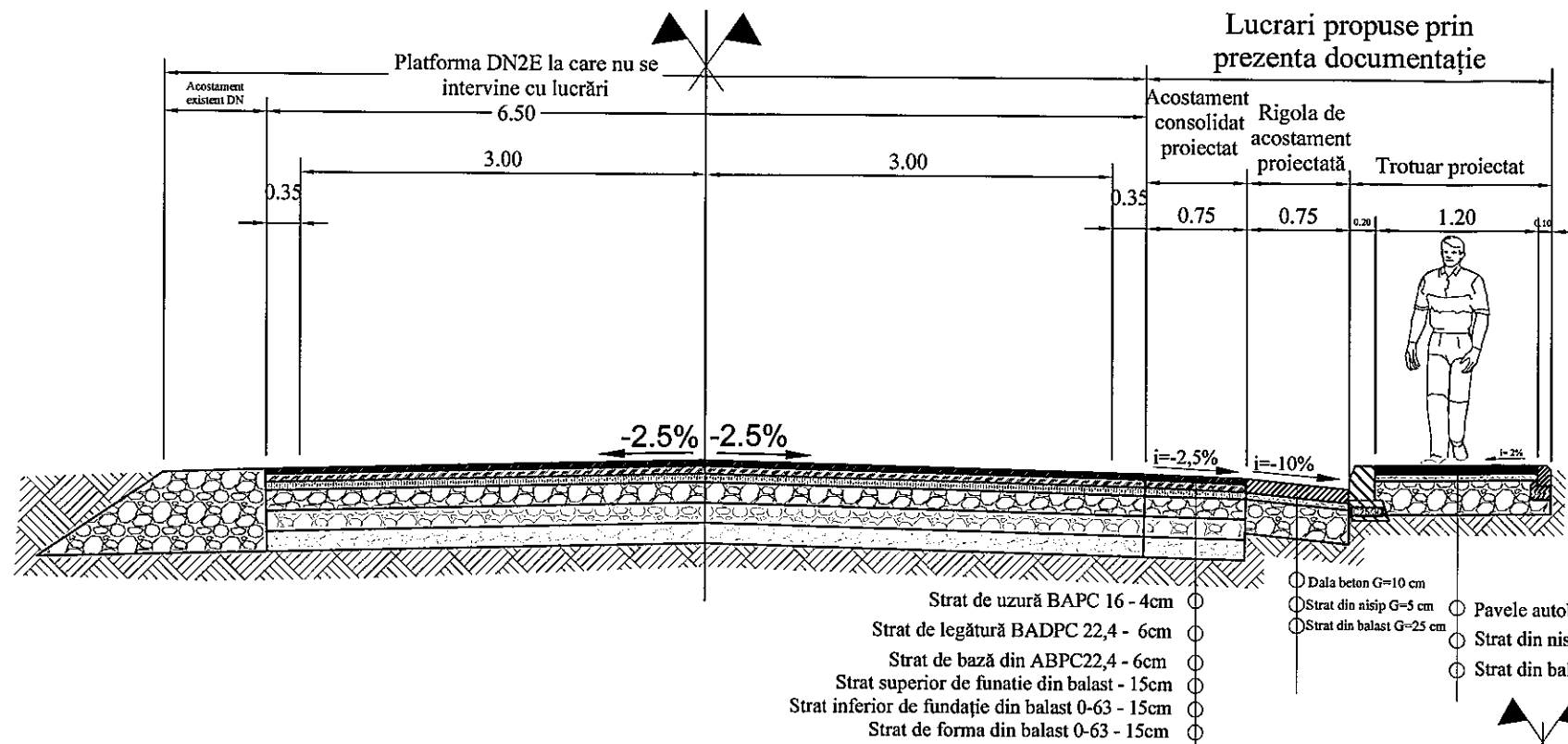

Se aplica de la km 41+267 la km 41+657

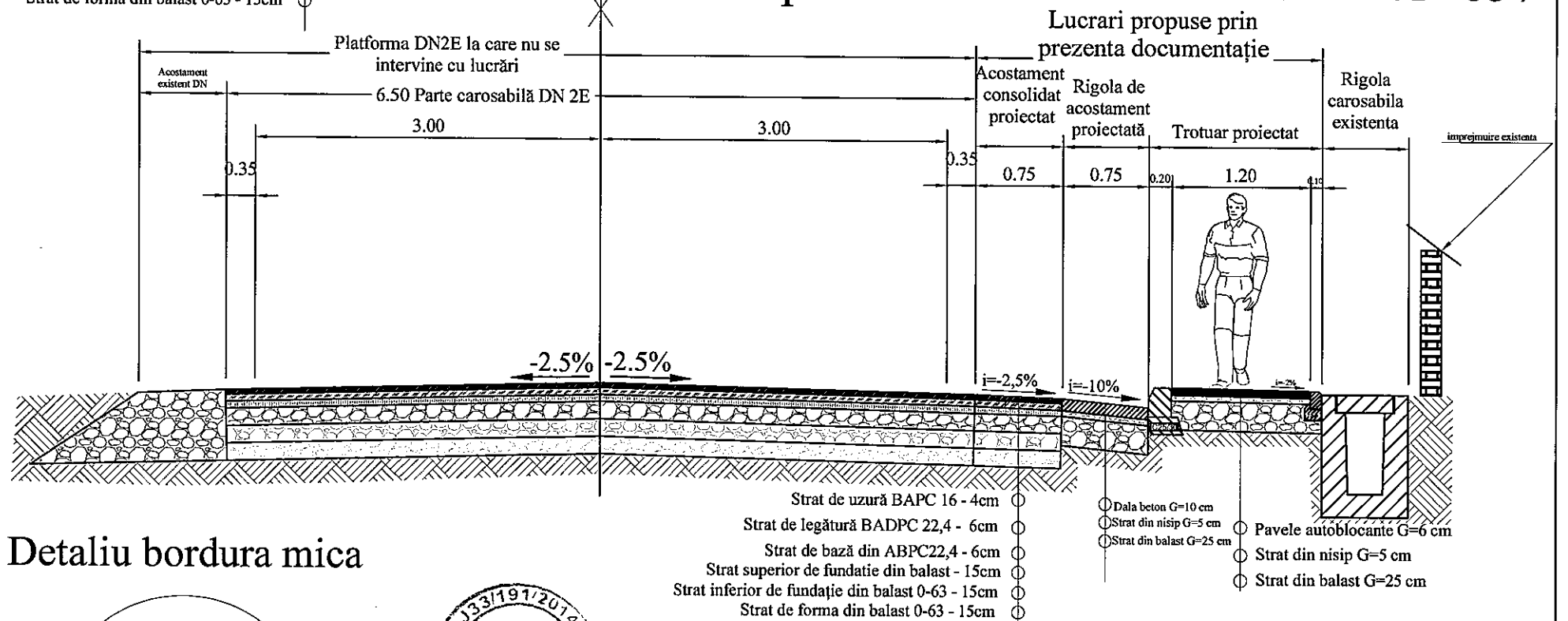

BETON-C30/37
 CLASA DE EXPUNERE-XF3
 GRAD DE GELIVITATE-G100
 RAPORT A/C-0.5
 TIP DE CIMENT-CEM I 32,5/0-16
 Ømaxim granula de agregat-32mm

Detaliu bordura mare

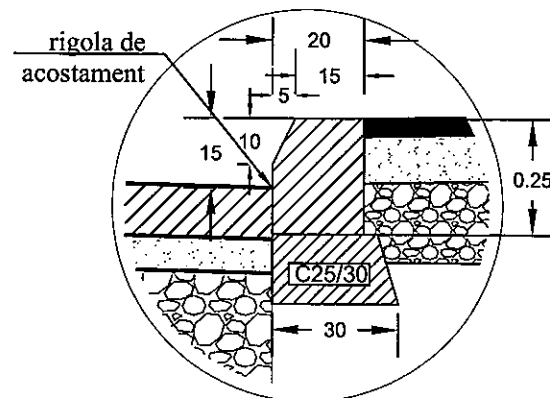

Detaliu bordura mica

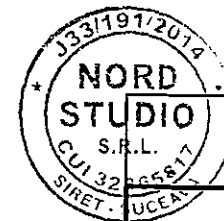
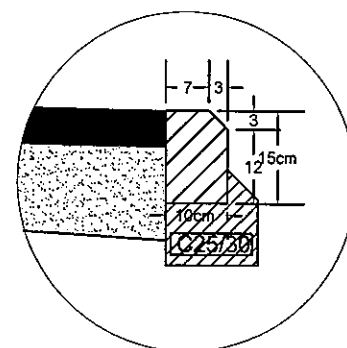

VERIFICATOR / EXPERT	NUME	SEMNTURA	CERINTA	REFERAT NR. / DATA
SC NORD STUDIO SRL J 33 / 191 / 2014				BENEFICIAR: COMUNA CACICA PROIECT: REFACERE SI MODERNIZARE ALEE PIETONALA AFERENTA DRUMULUI NATIONAL DN2E - PARTEA DREAPTA, IN SATUL PARTESTII DE SUS, COMUNA CACICA, JUDETUL SUCEAVA AMPLASAMENT: COMUNA CACICA, JUD. SUCEAVA
SEF PROIECT	ing. Costiuc E.		SCARA	PROIECT NR. 269/2022
PROIECTAT	ing. Ursu T.		1:50	FAZA P.T.
DESENAT	ing. Postelnicu P.		2023	PLANSA D.5.
PROFIL TRANSVERSAL TIP				

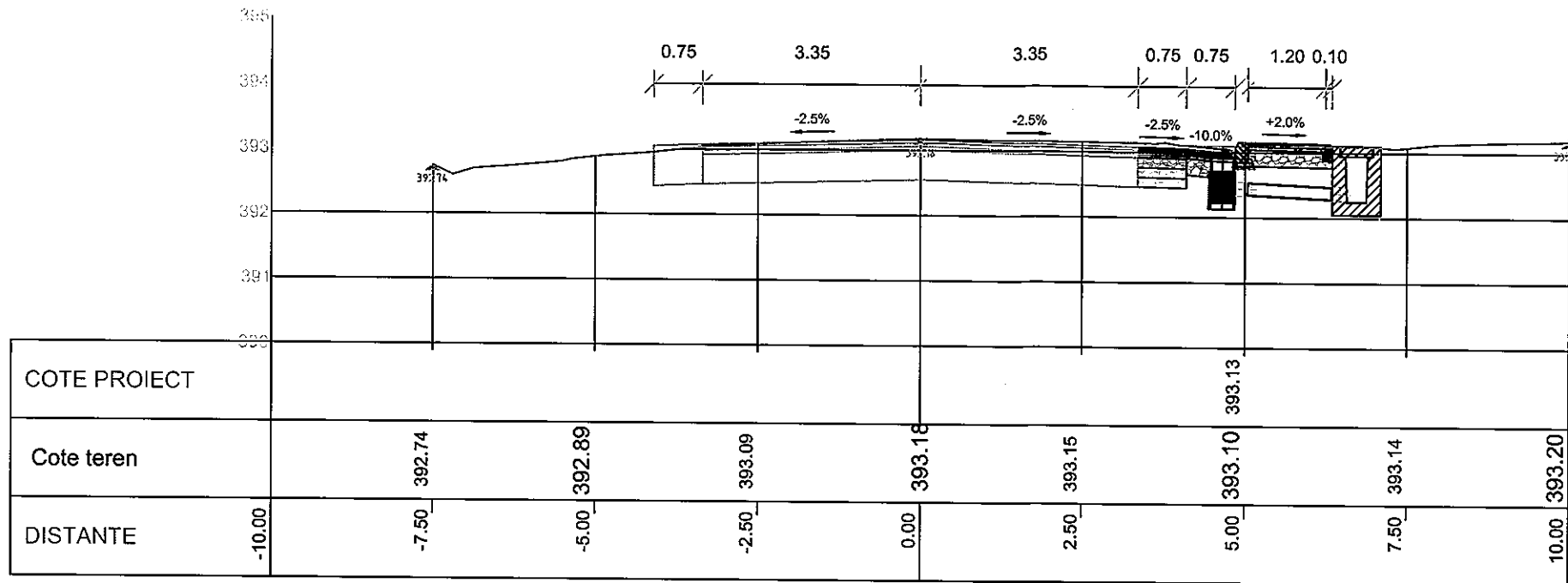

Km 41+267
Pichet nr.1

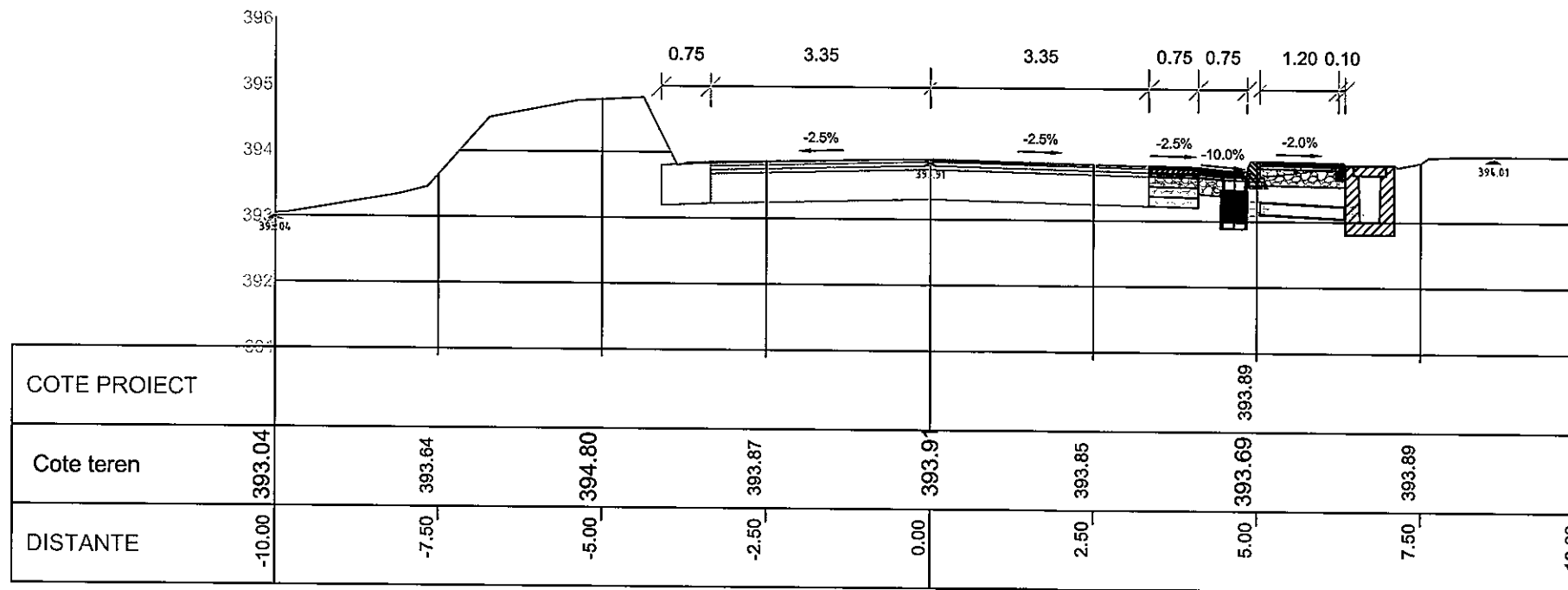

Km 41+306.676
Pichet nr.2



VERIFICATOR / EXPERT				NUME	SEMNATURA	GERINTA	REFERAT NR. / DATA	
SC NORD STUDIO SRL J 33 / 191 / 2014							BENEFICIAR: COMUNA CACICA PROIECT: REFACERE SI MODERNIZARE ALEE PIETONALA AFERENTA DRUMULUI NATIONAL DN2E - PARTEA DREAPTA, IN SATUL PARTESTII DE SUS, COMUNA CACICA, JUDETUL SUCEAVA AMPLASAMENT: COMUNA CACICA, JUD. SUCEAVA	PROIECT NR. 269/2022 FAZA P.T.
SEF PROIECT	ing. Costiuc E.					SCARA 1:100	PROFIL TRANSVERSAL CARACTERISTIC GIGER	
PROIECTAT	ing. Ursu T.							
DESENAT	ina. Postelnicu P.					2022		
							PLANSA D.6.1	

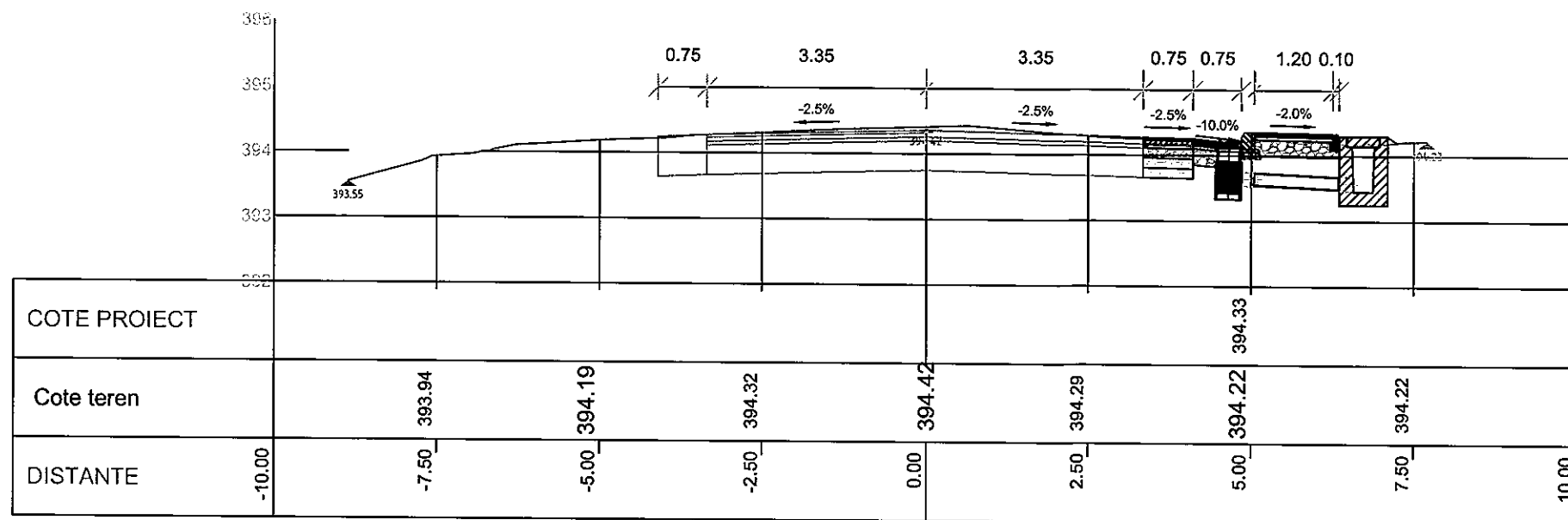

Km 41+356.158
Pichet nr.3

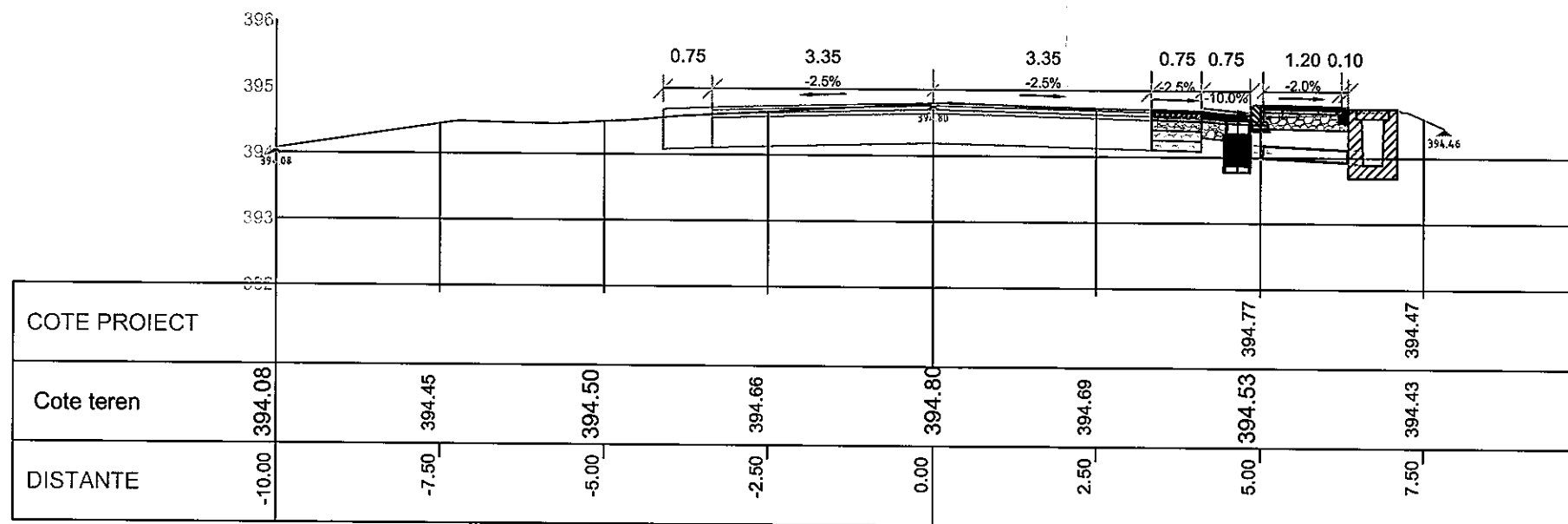

Km 41+406.015
Pichet nr.4

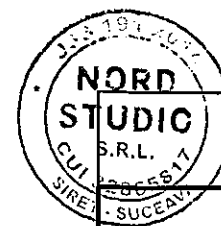

VERIFICATOR / EXPERT	NUME	SEM NATURA	CERINTA	REFERAT NR. / DATA
SC NORD STUDIO SRL J 33 / 191 / 2014				BENEFICIAR: COMUNA CACICA PROIECT: REFACERE SI MODERNIZARE ALEE PIETONALA AFERENTA DRUMULUI NATIONAL DN2E - PARTEA DREAPTA, IN SATUL PARTESTII DE SUS, COMUNA CACICA, JUDETUL SUCEAVA AMPLASAMENT: COMUNA CACICA, JUD. SUCEAVA
SEF PROIECT	ing. Costiuc E.		SCARA	PROIECT NR. 269/2022
PROIECTAT	ing. Ursu T.		1:100	FAZA P.T.
DESENAT	ina. Postelnicu P.		2022	PLANSA D.6.2
PROFIL TRANSVERSAL CARACTERISTIC GEIGER				

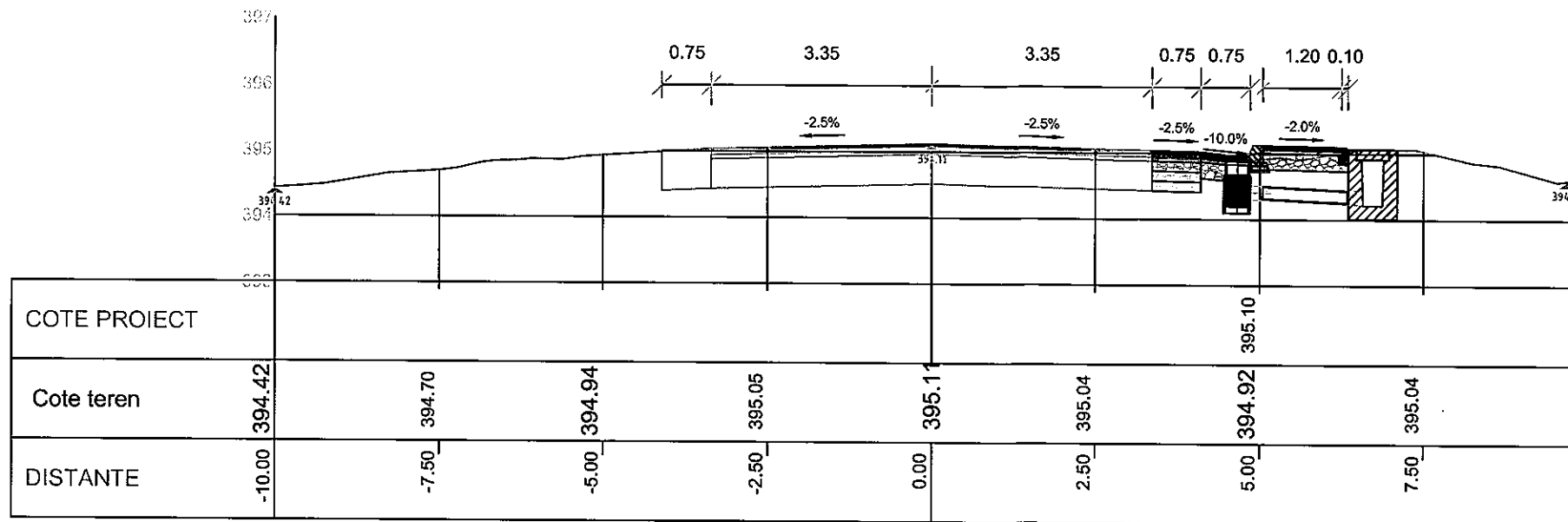

Km 41+456.651
Pichet nr.5

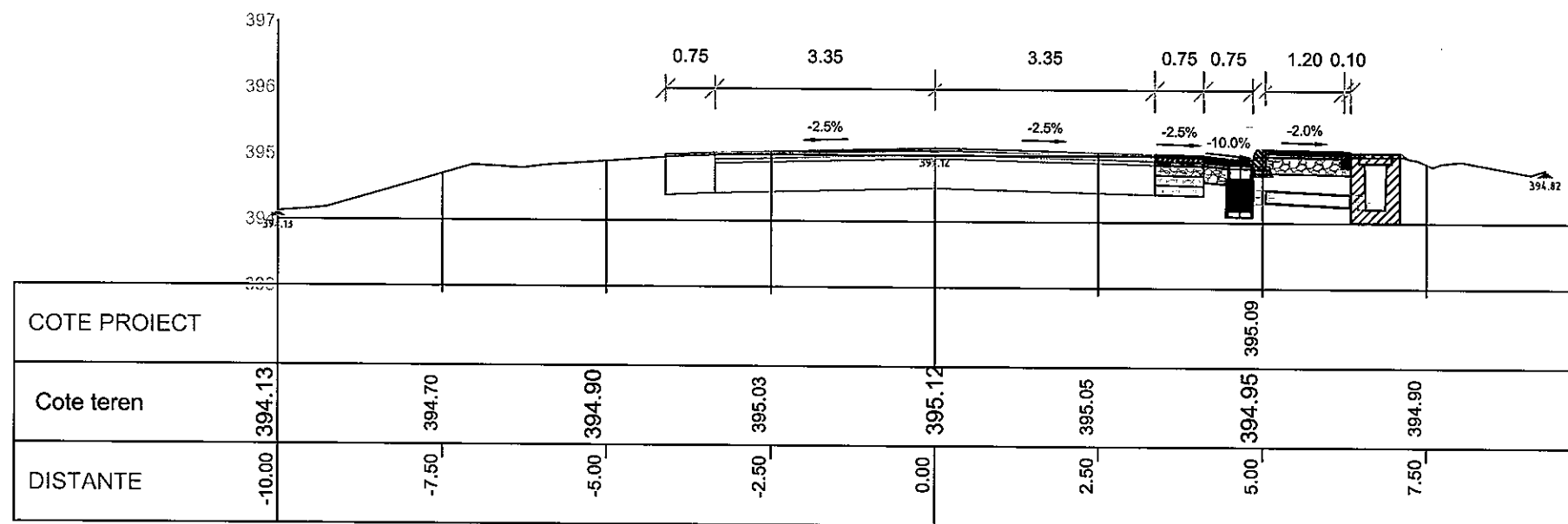

Km 41+506.363
Pichet nr.6

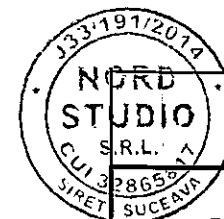

VERIFICATOR / EXPERT				NUME	SEMNATURA	CERINTA	REFERAT NR. / DATA	
SC NORD STUDIO SRL J 33 / 191 / 2014							BENEFICIAR: COMUNA CACICA PROIECT: REFACERE SI MODERNIZARE ALEE PIETONALA AFERENTA DRUMULUI NATIONAL DN2E - PARTEA DREAPTA, IN SATUL PARTESTII DE SUS, COMUNA CACICA, JUDETUL SUCEAVA AMPLASAMENT: COMUNA CACICA, JUD. SUCEAVA	PROIECT NR. 269/2022
SEF PROIECT	ing. Costiuc E.					SCARA 1:100	FAZA P.T.	
PROIECTAT	ing. Ursu T.						PLANSA D.6.3	
DESENAT	ing. Postelnicu P.							

**PROFIL TRANSVERSAL
CARACTERISTIC GEIGER**

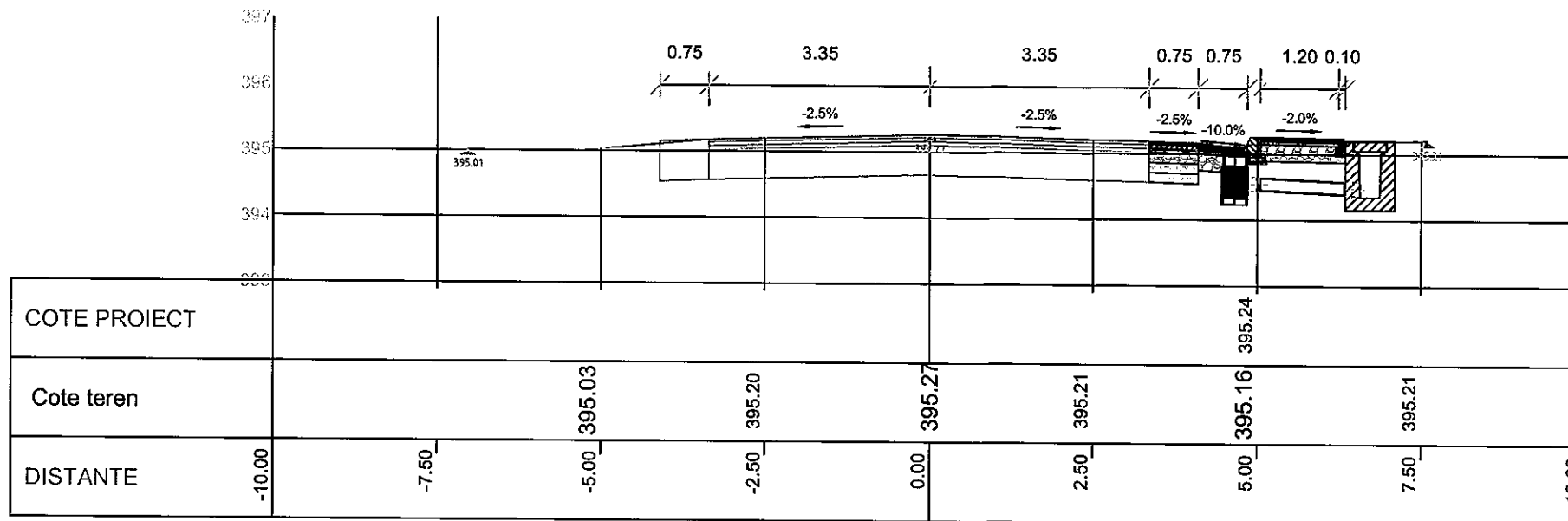

Km 41+556.701
Pichet nr.7

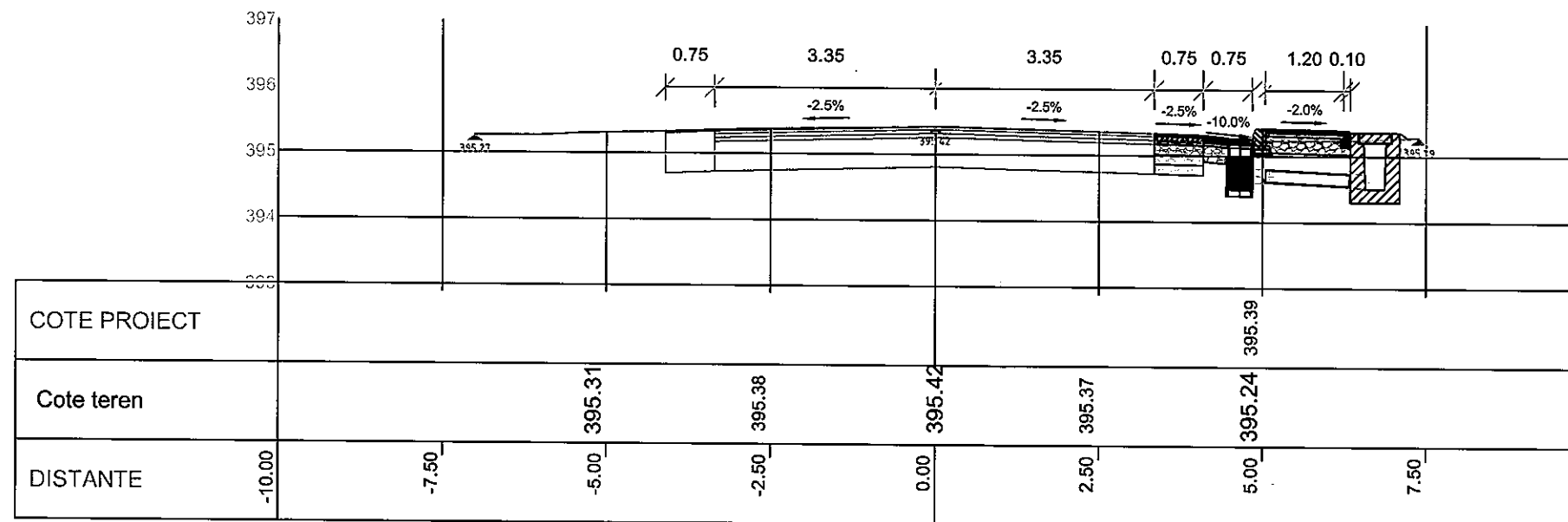

Km 41+607.361
Pichet nr.8



				REFERAT NR. / DATA	
VERIFICATOR / EXPERT	NUME	SEMNATURA	CERINTA	BENEFICIAR: COMUNA CACICA PROIECT: REFACERE SI MODERNIZARE ALEE PIETONALA AFERENTA DRUMULUI NATIONAL DN2E - PARTEA DREAPTA, IN SATUL PARTESTII DE SUS, COMUNA CACICA, JUDETUL SUCEAVA AMPLASAMENT: COMUNA CACICA, JUD. SUCEAVA	
SC NORD STUDIO SRL J 33 / 191 / 2014				PROIECT NR. 269/2022	
SEF PROIECT	ing. Costiuc E.	<i>[Signature]</i>	SCARA 1:100	FAZA P.T.	
PROIECTAT	ing. Ursu T.	<i>[Signature]</i>		PLANSA D.6.4	
DESENAT	ing. Postelnicu P.	<i>[Signature]</i>	2023		
				PROFIL TRANSVERSAL CARACTERISTIC GEIGER	

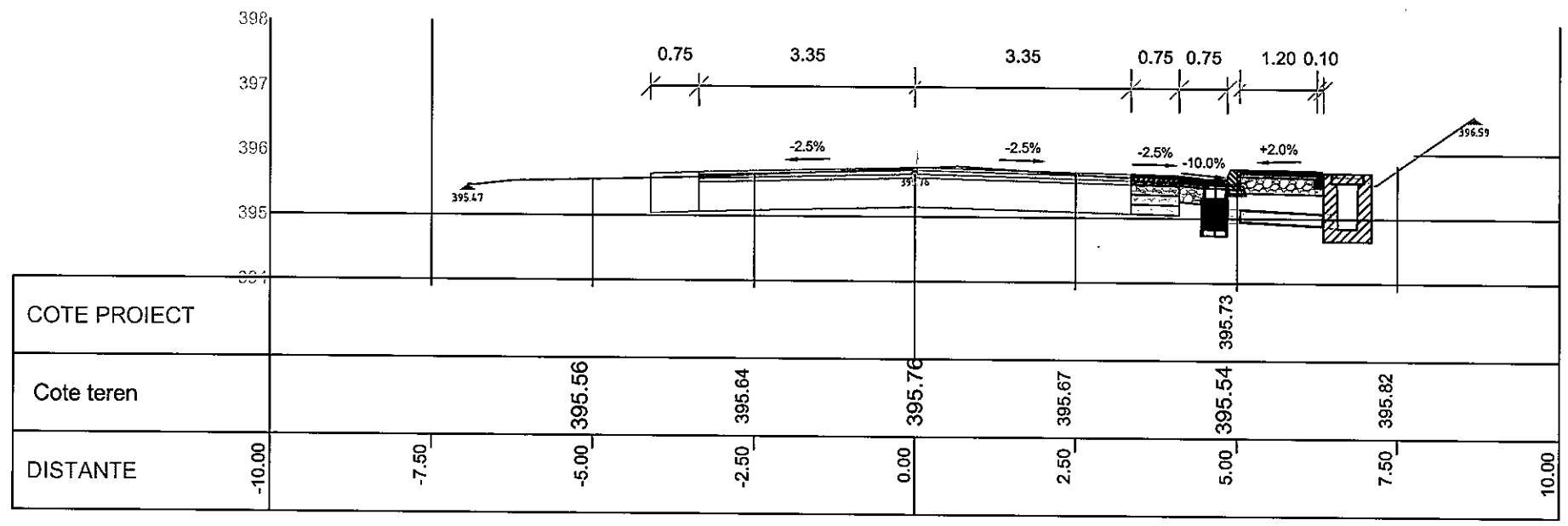

Km 41+657.184
Pichet nr.9

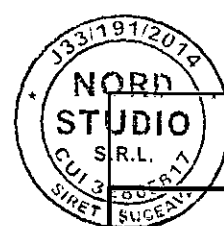

VERIFICATOR / EXPERT		NUME	SEMNATURA	CERINTA	REFERAT NR. / DATA	
SC NORD STUDIO SRL J 33 / 191 / 2014					BENEFICIAR: COMUNA CACICA PROIECT: REFACERE SI MODERNIZARE ALEE PIETONALA AFERENTA DRUMULUI NATIONAL DN2E - PARTEA DREAPTA, IN SATUL PARTESTII DE SUS, COMUNA CACICA, JUDETUL SUCEAVA AMPLASAMENT: COMUNA CACICA, JUD. SUCEAVA	
SEF PROIECT	ing. Costiuc E.			SCARA	PROIECT NR. 269/2022	
PROIECTAT	ing. Ursu T.			1:100	FAZA P.T.	
DESENAT	ing. Postelnicu P.			2023	PLANSA D.6.5	
					PROFIL TRANSVERSAL CARACTERISTIC GEIGER	

D.7 Planşa	DETALIU GEIGER SCURGERE	DESEMAT	Ing. Postelnicu P.
		PROIECTAT	Ing. Ursu T.
Faza: P.T.	TITLUL PLANSEI: AMPLASAMENT: COMUNA CACICA, JUDEUL SUCEAVA PARTESTII DE SUS, COMUNA CACICA, JUDEUL SUCEAVA DRUMULUI NATIONAL DN2E - PARTEA DREAPTA, IN SATUL PENTRU: REFACERE SI MODERNIZARE ALEE PIETONALA AFERENTA BENEFICIAR: COMUNA CACICA	SEF PROIECT	Ing. Costuc E.
		SPECIFICATIE	Numere: Semnatura: Scara: 1:20
PROIECT 269/2022		REFERAT de verificare/RAPORT de expertiza tehnica	titlu/numar/data

S.C. NORD STUDIO S.R.L.
SUCEAVA
J 33/191/2014

